

Memorex®

Is it live or is it Memorex?™

MVDR2100

User's Guide

DVD VIDEO RECORDER

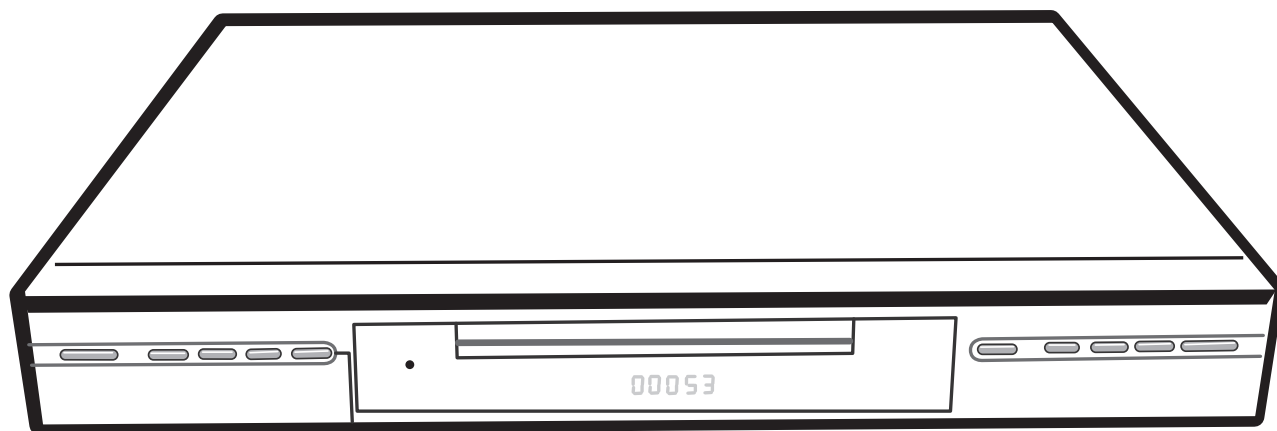

COMPACT
disc
DIGITAL AUDIO

BUILT-IN
MP3
DECODER®

DVD
VIDEO

DD DOLBY
DIGITAL

dts
DIGITAL OUT

Before operating this product,
please read these instructions completely.

CONTENTS

Contents	1	• Chapter Search.....	31
Important Safety Instructions	2	• Time Search.....	31
Precautions	5	• Mute	31
Power Source	5	• Repeat Playback.....	32
Location of Controls	6	• A-B Repeat Playback.....	32
• Front.....	6	• Random Playback.....	32
• Rear	6	• Angle.....	32
• Remote	7	• Return	33
Remote Control	8	• Audio.....	33
• Battery Installation	8	• DVD Menu	33
• Effective Distance of the Remote Control Transmitter	8	• Title Menu	33
Connection	9	• Subtitle Menu.....	33
• Connecting the DVD to a TV and CATV Using the RF Input/Output Jacks.....	9	• Programmed Playback.....	34
• Connecting the DVD to a TV Using the Audio/Video Output Jacks	10	MP3 Basic Operation	35
• Connecting the DVD to a TV Using the S-Video Output Jack	11	• Playback of an MP3.....	35
• Connecting the DVD to a TV Using the Component Jacks	12	• Random Play	36
• Progressive (YUV) VIDEO OUT	12	• Repeat Play	36
• 525 Line Digital Progressive-scan Component Video Output.....	12	• Selecting Folders/Tracks	36
• Connecting the DVD to a Home Theatre System.....	13	• Audio.....	36
• Connecting an External Unit Using the Audio/Video In Jacks	14	• MP3 FAQs.....	36
• Connecting an External Unit Using the S-Video In Jack.....	14	• Programmed Playback.....	37
• Connecting an External Unit Using the DV IN Jack.....	15	CD/VCD Basic Operation	38
• Connecting an External Unit Using the Front S-Video or A/V In Jacks	15	• Playback of a CD/VCD	38
About Discs	16	• Turning PBC (PlayBack Control) ON orOFF	38
Setup Menu	18	• Forward/Reverse	39
• General Setup Menu.....	19	• Repeat Play	39
• Play Setup Menu	20	• Selecting Tracks.....	39
• Record Setup Menu.....	21	• Audio.....	39
• Language Setup Menu	22	• Random Play	39
• Tuner Setup Menu	23	• Time Search.....	39
• Clock Setup Menu	24	• Programmed Playback (CD).....	40
• Setting the Rating Level.....	25	• Programmed Playback (VCD)	41
• Changing the Password.....	25	Picture CD Basic Operation	42
TV Operation	26	Recording	43
DVD Basic Operation	27	• Display Button.....	43
• Display Button (DVD Mode).....	27	• Recording.....	44
• Playback of a DVD.....	28	• One-Touch Recording	45
• Playback of a Prerecorded DVD+RW or DVD+R..	29	• Timer Record	46
• Skip	30	• Using the Edit menu	47
• Search.....	30	• Chapter Editing	48
• Slow/F	30	• Title Icon and Title Name	48
• Pause/Step	30	• Disc Operation (DISC OP) Button	49
• Title Search.....	31	Troubleshooting Guide	50
		Care and Maintenance	52
		Specifications	53

IMPORTANT SAFETY INSTRUCTIONS

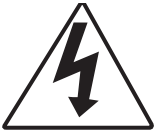

CAUTION

**RISK OF ELECTRIC SHOCK
DO NOT OPEN**



The lightning flash with arrowhead symbol within an equilateral triangle is intended to alert the user to the presence of uninsulated dangerous voltage within the product's enclosure that may be of sufficient magnitude to constitute a risk of electric shock to persons.



The exclamation point within an equilateral triangle is intended to alert the user to the presence of important operating and maintenance (servicing) instructions in the literature accompanying the appliance.

CAUTION: TO REDUCE THE RISK OF ELECTRIC SHOCK, DO NOT REMOVE COVER (OR BACK). NO USER-SERVICEABLE PARTS INSIDE. REFER SERVICING TO QUALIFIED SERVICE PERSONNEL.

CAUTION:

THIS DIGITAL VIDEO DISC PLAYER EMPLOYS A LASER SYSTEM.

TO ENSURE PROPER USE OF THIS PRODUCT, PLEASE READ THIS OWNER'S MANUAL CAREFULLY AND RETAIN FOR FUTURE REFERENCE. SHOULD THE UNIT REQUIRE MAINTENANCE, CONTACT AN AUTHORIZED SERVICE LOCATION-SEE SERVICE PROCEDURE.

USE OF CONTROLS, ADJUSTMENTS OR THE PERFORMANCE OF PROCEDURES OTHER THAN THOSE SPECIFIED HEREIN MAY RESULT IN HAZARDOUS RADIATION EXPOSURE.

TO PREVENT DIRECT EXPOSURE TO LASER BEAM, DO NOT TRY TO OPEN THE ENCLOSURE. VISIBLE LASER RADIATION MAY BE PRESENT WHEN THE ENCLOSURE IS OPENED. DO NOT STARE INTO BEAM.

WARNING:

TO REDUCE THE RISK OF FIRE OR ELECTRIC SHOCK, DO NOT EXPOSE THIS PRODUCT TO RAIN OR MOISTURE.

WARNING:

TO REDUCE THE RISK OF FIRE OR ELECTRIC SHOCK, AND ANNOYING INTERFERENCE, USE THE RECOMMENDED ACCESSORIES ONLY.

SURGE PROTECTORS:

It is recommended to use a surge protector for AC connection. Lightning and power surges ARE NOT covered under warranty for this product.

FCC NOTICE:

This equipment has been tested and found to comply with the limits for a Class B digital device, pursuant to part 15 of the FCC Rules. These limits are designed to provide reasonable protection against harmful interference in a residential installation. This equipment generates, uses and can radiate radio frequency energy and, if not installed and used in accordance with the instructions, may cause harmful interference to radio communications.

However, there is no guarantee that interference will not occur in a particular installation. If this equipment does cause harmful interference to radio or television reception, which can be determined by turning the equipment off and on, the user is encouraged to try to correct the interference by one or more of the following measures:

- Reorient or relocate the receiving antenna.
- Increase the separation between the equipment and receiver.
- Connect the equipment into an outlet on a circuit different from that to which the receiver is connected.
- Consult the dealer or an experienced radio/TV technician for help.

FCC CAUTION:

To assure continued compliance, follow the attached installation instructions and use only shielded cables when connecting to other devices. Also, any changes or modifications not expressly approved by the party responsible for compliance could void the user's authority to operate the equipment.

Manufactured under license from Dolby Laboratories.

"Dolby" and the double-D symbol are trademarks of Dolby Laboratories.

IMPORTANT SAFETY INSTRUCTIONS (CONTINUED)

IMPORTANT:

PLEASE KEEP ALL PACKAGING MATERIAL FOR AT LEAST 90 DAYS IN CASE YOU NEED TO RETURN THIS PRODUCT TO YOUR PLACE OF PURCHASE OR TO MEMOREX.

Before using the unit, be sure to read all operating instructions carefully. Please note that these are general precautions and may not pertain to your unit. For example, this unit may not have the capability to be connected to an outdoor antenna.

1. READ INSTRUCTIONS

All the safety and operating instructions should be read before the product is operated.

2. RETAIN INSTRUCTIONS

The safety and operating instructions should be retained for future reference.

3. HEED WARNINGS

All warnings on the product and in the operating instructions should be adhered to.

4. FOLLOW INSTRUCTIONS

All operating and use instructions should be followed.

5. CLEANING

Unplug this product from the wall outlet before cleaning. Do not use liquid cleaners or aerosol cleaners. Use a dry cloth for cleaning.

6. ATTACHMENTS

Do not use attachments not recommended by the product's manufacturer as they may cause hazards.

7. WATER AND MOISTURE

Do not use this product near water-for example: near a bathtub, washbowl, kitchen sink, or laundry tub; in a wet basement; or near a swimming pool.

8. ACCESSORIES

Do not place this product on an unstable cart, stand, tripod, bracket, or table. The product may fall, causing serious injury and serious damage to the product. Use only with a cart, stand, tripod, bracket, or table recommended by the manufacturer or sold with the product. Any mounting of the product should follow the manufacturer's instructions, and should use a mounting accessory recommended by the manufacturer.

PORTABLE CART WARNING
(symbol provided by RETAC)



S3126A

8A. An appliance and cart combination should be moved with care. Quick stops, excessive force, and uneven surfaces may cause the appliance and cart combination to overturn.

9. VENTILATION

Slots and openings in the cabinet and in the back or bottom are provided for ventilation, to ensure reliable operation of the product and to protect it from overheating. These openings must not be blocked or covered. The openings should never be blocked by placing the product on a bed, sofa, rug, or other similar surface. This product should never be placed near or over a radiator or heat source. This product should not be placed in a built-in installation such as a bookcase or rack unless proper ventilation is provided or the manufacturer's instructions have been adhered to.

10. POWER SOURCES

This product should be operated only from the type of power source indicated on the marking label. If you are not sure of the type of power supply to your home, consult your appliance dealer or local power company. For products intended to operate from battery power, or other sources, refer to the operating instructions.

11. GROUNDING OR POLARIZATION

This product is equipped with a polarized alternating-current line plug (a plug having one blade wider than the other). This plug will fit into the power outlet only one way. This is a safety feature. If you are unable to insert the plug fully into the outlet, try reversing the plug. If the plug should still fail to fit, contact your electrician to replace your obsolete outlet. Do not defeat the safety purpose of the polarized plug.

12. POWER-CORD PROTECTION

Power-supply cords should be routed so that they are not likely to be walked on or pinched by items placed upon or against them, paying particular attention to cords at plugs, convenience receptacles, and the point where they exit from the appliance.

13. LIGHTNING

To protect your product from a lightning storm, or when it is left unattended and unused for long periods of time, unplug it from the wall outlet and disconnect the antenna or cable system. This will prevent damage to the product due to lightning and power-line surges.

14. POWER LINES

An outside antenna system should not be located in the vicinity of overhead power lines or other electric light or power circuits, or where it can fall into such power lines or circuits. When installing an outside antenna system, extreme care

IMPORTANT SAFETY INSTRUCTIONS (CONTINUED)

should be taken to keep from touching such power lines or circuits as contact with them might be fatal.

15. OVERLOADING

Do not overload wall outlets and extension cords as this can result in a risk of fire or electric shock.

16. OBJECT AND LIQUID ENTRY

Never push objects of any kind into this product through openings as they may touch dangerous voltage points or short out parts that could result in fire or electric shock. Never spill or spray any type of liquid on the product.

17. OUTDOOR ANTENNA GROUNDING

If an outside antenna is connected to the product, be sure the antenna system is grounded so as to provide some protection against voltage surges and built-up static charges. Section 810 of the National Electric Code, ANSI/NFPA 70, provides information with respect to proper grounding of the mast and supporting structure, grounding of the lead-in wire to an antenna discharge product, size of grounding conductors, location of antenna discharge product, connection to grounding electrodes, and requirements for grounding electrode.

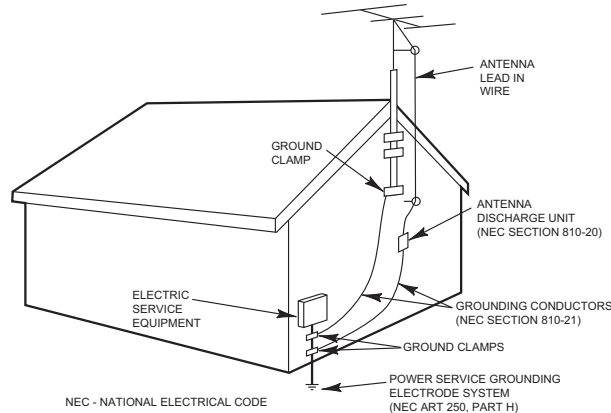

EXAMPLE OF ANTENNA GROUNDING AS PER
NATIONAL ELECTRICAL CODE

18. SERVICING

Do not attempt to service this product yourself as opening or removing covers may expose you to dangerous voltage or other hazards. Refer all servicing to qualified service personnel.

19. REPLACEMENT PARTS

When replacement parts are required, be sure the service technician uses replacement parts specified by the manufacturer or those that have the same characteristics as the original part. Unauthorized substitutions may result in fire, electric shock or other hazards.

20. SAFETY CHECK

Upon completion of any service or repairs to this product, ask the service technician to perform safety checks to determine that the product is in proper operating condition.

21. WALL OR CEILING MOUNTING

The product should be mounted to a wall or ceiling only as recommended by the manufacturer.

22. DAMAGE REQUIRING SERVICE

Unplug the product from the wall outlet and refer servicing to qualified service personnel under the following conditions:

- When the power-supply cord or plug is damaged.
- If liquid has been spilled, or objects have fallen into the product.
- If the product has been exposed to rain or water.
- If the product does not operate normally by following the operating instructions. Adjust only those controls that are covered by the operating instructions, as an adjustment of other controls may result in damage and will often require extensive work by a qualified technician to restore the product to its normal operation.
- If the product has been dropped or the cabinet has been damaged.
- When the product exhibits a distinct change in performance-this indicates a need for service.

23. HEAT

The product should be situated away from heat sources such as radiators, heat registers, stoves, or other products (including amplifiers) that produce heat.

24. NOTE TO CATV SYSTEM INSTALLER

This reminder is provided to call the CATV system installer's attention to Article 820-40 of the NEC that provides guidelines for proper grounding and, in particular, specifies that the cable ground shall be connected to the grounding system of the building, as close to the point of cable entry as practical.

PRECAUTIONS

NOTES ON HANDLING:

- When shipping the DVD recorder, always use the original shipping carton and packing materials. For maximum protection, repack the unit as it was originally packed at the factory.
- Do not use volatile liquids, such as insect spray, near the DVD recorder. Do not leave rubber or plastic products in contact with the DVD recorder for a long time. They will leave marks on the finish.
- The top and rear panels of the DVD recorder may become warm after a long period of use. This is normal and not a malfunction.
- When the DVD recorder is not in use, be sure to remove the disc and turn off the power.
- If you do not use the DVD recorder for a long period, the unit may not function properly in the future. Turn on and use the DVD recorder occasionally.

NOTES ON LOCATING THE DVD recorder:

- When you place this DVD recorder near a TV, radio or VCR, the playback picture may become poor and the sound may be distorted. In this case, move the DVD recorder away from the TV, radio or VCR.

NOTES ON CLEANING:

Use a soft, dry cloth for cleaning.

- For stubborn dirt, soak the cloth in a weak detergent solution, wring well and wipe. Use a dry cloth to wipe it dry. Do not use any type of solvent, such as thinner and benzene, as they may damage the surface of the DVD recorder.
- If you use a chemical-saturated cloth to clean the unit, follow that product's instructions.

Warning: Cleaning and adjustment of lenses and/or other components of playback mechanism should be performed by a qualified service technician.

TO OBTAIN A CLEAR PICTURE:

The DVD recorder is a high technology, precision device. If the optical pick-up lens and disc drive parts are dirty or worn down, the picture quality becomes poor. To obtain a clear picture, we recommend regular inspection and maintenance (cleaning or parts replacement) every 1,000 hours of use depending on the operating environment. For details, contact your nearest dealer.

NOTES ON MOISTURE CONDENSATION:

Moisture condensation damages the DVD recorder. Please read the following carefully.

- Moisture condensation occurs, for example, when you pour a cold drink into a glass on a warm day. Drops of water form on the outside of the glass. In the same way, moisture may condense on the optical pick-up lens inside this unit, one of the most crucial internal parts of the DVD recorder.

Moisture condensation occurs during the following cases:

- When you bring the DVD recorder directly from a cold place to a warm place.
- When you use the DVD recorder in a room where you just turned on the heater, or a place where the cold wind from the air conditioner directly hits the unit.
- In summer, when you use the DVD recorder in a hot and humid place just after you moved the unit from an air conditioned room.
- When you use the DVD recorder in a humid place.

Do not use the DVD recorder when moisture condensation may occur.

- If you use the DVD recorder in such a situation, it may damage discs and internal parts. Remove the disc, connect the power cord of the DVD recorder to the wall outlet, turn on the DVD recorder and leave it "ON" for two or three hours. After two or three hours, the DVD recorder will have warmed up and evaporated any moisture. Keep the DVD recorder connected to the wall outlet and moisture

POWER SOURCE

Insert the AC plug (with the 2 blades) into a conveniently located AC outlet having 120V, 60Hz.

NOTE: The AC plug supplied with the unit is polarized to help minimize the possibility of electric shock. If the AC plug does not fit into a nonpolarized AC outlet, do not file or cut the wide blade. It is the user's responsibility to have an electrician replace the obsolete outlet.

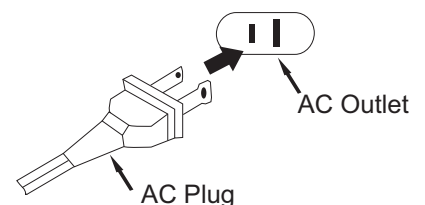

LOCATION OF CONTROLS

FRONT

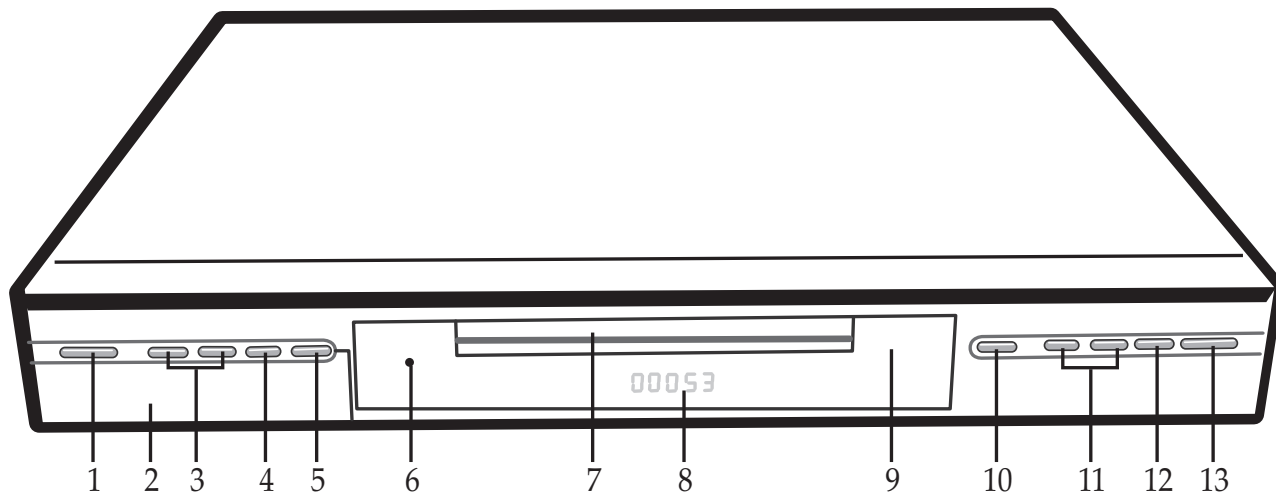

- | | |
|--|---|
| 1. ON/STANDBY Button | 7. Disc Tray |
| 2. DV IN Jack, S-Video IN Jack and A/V IN Jacks (under door) | 8. Display |
| 3. CHANNEL Up/Down Buttons | 9. Remote Sensor |
| 4. SOURCE Button | 10. OPEN/CLOSE Button |
| 5. RECORD Button | 11. SKIP ⏮ / ⏭ Button |
| 6. STANDBY Indicator | 12. STOP ■ Button |
| | 13. PLAY/PAUSE ▶ / ⏸ Button |

REAR

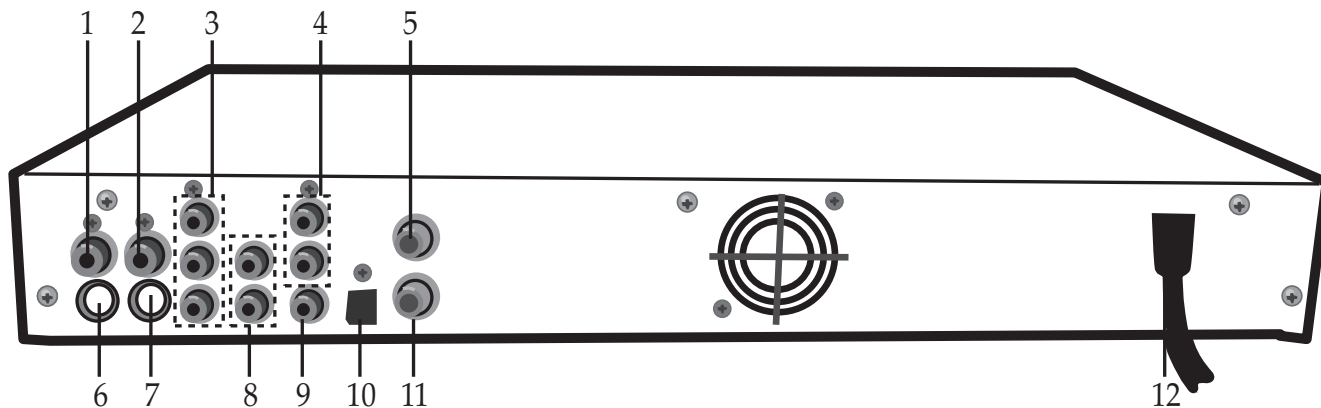

- | | |
|---|---|
| 1. Video IN Jack | 7. S-Video OUT Jack |
| 2. Video OUT Jack | 8. Stereo Audio Left/Right Output Jacks |
| 3. Component Video (Y, U, V) Output Jacks | 9. Coaxial Digital Audio Output Jack |
| 4. Stereo Audio Left/Right Input Jacks | 10. Optical Digital Audio Output Jack |
| 5. RF IN Jack | 11. RF OUT Jack |
| 6. S-Video IN Jack | 12. AC Power Cord |

LOCATION OF CONTROLS (CONTINUED)

REMOTE

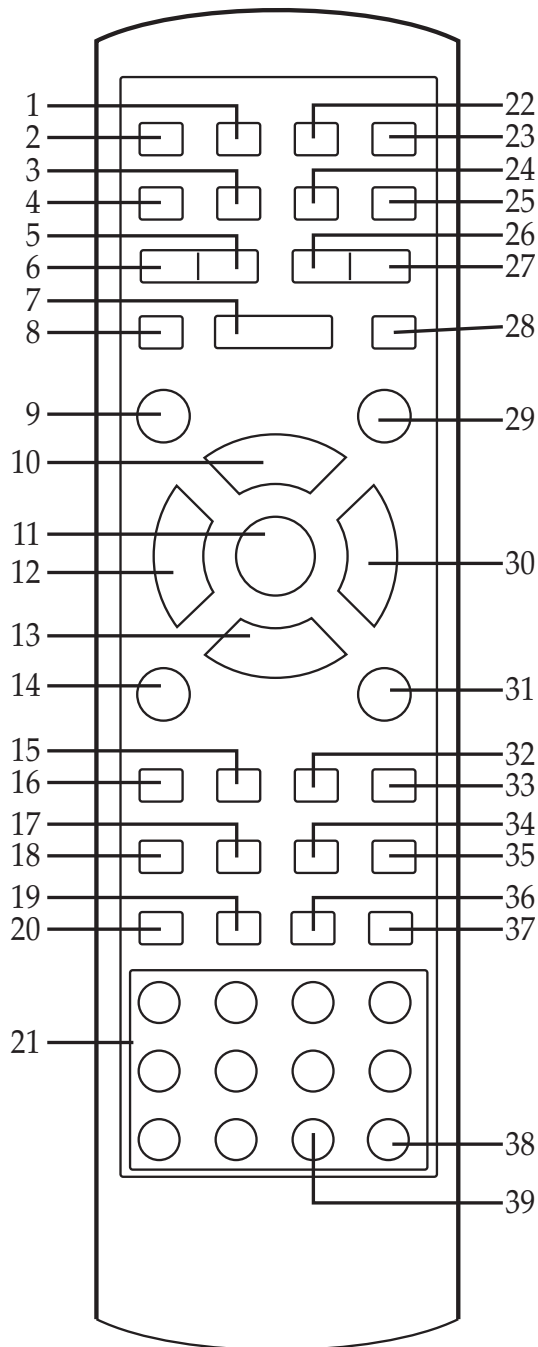

1. DISPLAY Button
2. MUTE Button
3. RANDOM Button
4. SLOW Button
5. FWD ►► Button
6. REV ◀◀ Button
7. PLAY (►) Button
8. PAUSE/STEP Button
9. TITLE Button
10. Navigation (▲) Button
11. ENTER Button
12. Navigation (◀) Button
13. Navigation (▼) Button
14. SETUP Button
15. EDIT Button
16. RETURN Button
17. SUBTITLE Button
18. I/P (Interlace/Progressive) Button
19. ANGLE Button
20. AUDIO Button
21. Number (0-9) Buttons
22. OPEN/CLOSE Button
23. STANDBY ON/OFF Button
24. REPEAT Button
25. TIMER Button
26. SKIP (◀◀) Button
27. SKIP (►►) Button
28. STOP (■) Button
29. MENU Button
30. Navigation (►) Button
31. DISC OPERATION Button
32. RECORD Button
33. SOURCE Button
34. CHANNEL Down Button
35. CHANNEL Up Button
36. VOLUME Down Button
37. VOLUME Up Button
38. GOTO Button
39. ADD/CLEAR Button

REMOTE CONTROL

BATTERY INSTALLATION

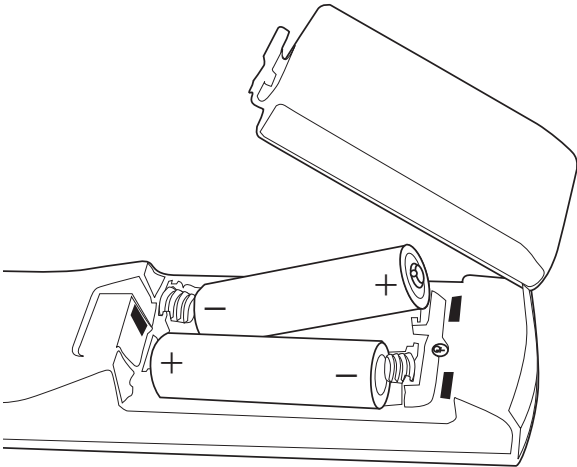

1. Open the battery compartment cover by pushing in on the tab and lifting it out.
2. Install two (2) "AA" batteries (not included), paying attention to the polarity diagram in the battery compartment.
3. Replace the battery compartment cover.

BATTERY PRECAUTIONS

Follow these precautions when using batteries in this device:

1. Use only the size and type of batteries specified.
2. Be sure to follow the correct polarity when installing the batteries as indicated next to the battery compartment. Reversed batteries may cause damage to the device.
3. Do not mix different types of batteries together (e.g. Alkaline, Rechargeable and Carbon-zinc) or old batteries with fresh ones.
4. If the device is not to be used for a long period of time, remove the batteries to prevent damage or injury from possible battery leakage.
5. Do not try to recharge batteries not intended to be recharged; they can overheat and rupture. (Follow battery manufacturer's directions.)

EFFECTIVE DISTANCE OF THE REMOTE CONTROL TRANSMITTER

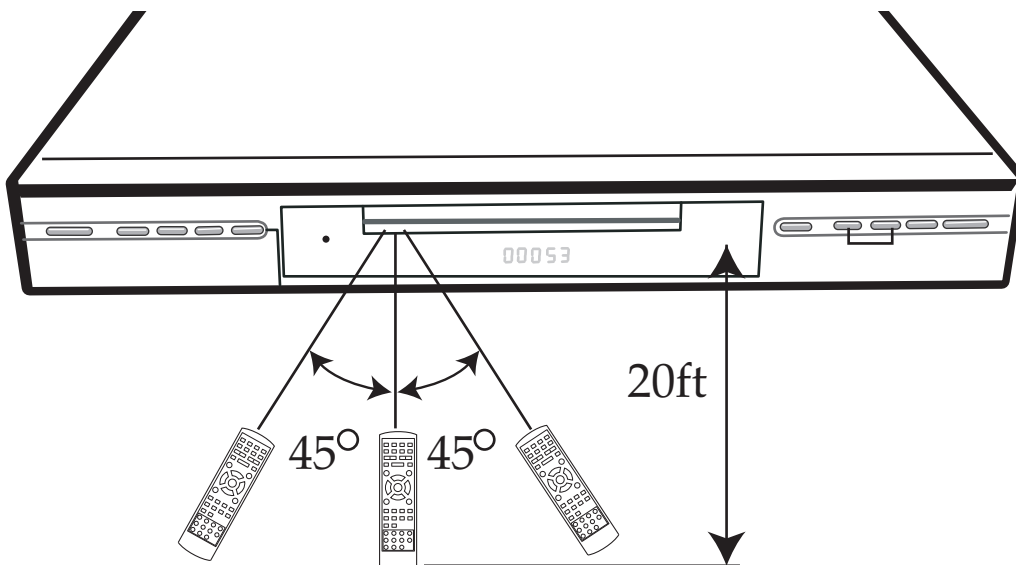

NOTES:

- When there is an obstacle between the DVD and the transmitter, the transmitter may not operate.
- When direct sunlight, an incandescent lamp, fluorescent lamp or any other strong light shines on the REMOTE SENSOR of the DVD, the remote operation may be unstable.

CONNECTION

CONNECTING THE DVD TO A TV AND CATV USING THE RF INPUT/OUTPUT JACKS

IMPORTANT:

This will only send the cable/satellite signal to the TV. To play a disc, you must connect using the A/V, S-Video or component outputs as described on the following pages.

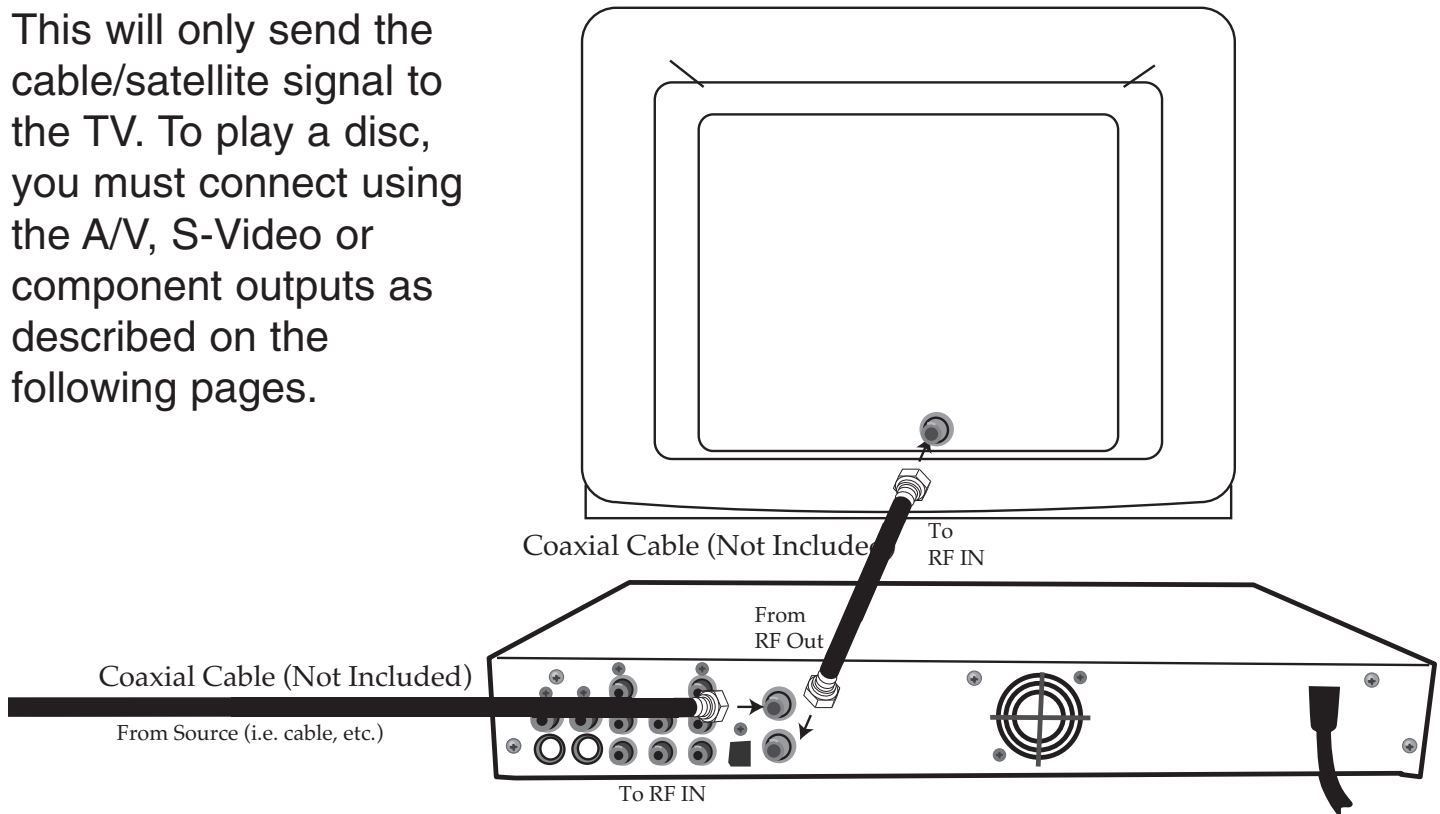

NOTES FOR CONNECTING TO CATV, SATELLITE, ETC.

- The signal will be sent to the TV regardless if the DVD recorder is on or off.
- If your TV has a Component input, connect the DVD recorder with the component cable for best results, otherwise use the S-Video or Video Out jack(s) on the DVD recorder.
- You can use the DVD recorders tuner to change channels, or you can use your TV's tuner.
- When connecting the DVD, refer to the owner's manual of the TV, as well as this manual.
- When connecting the DVD to the TV, make sure the power is off and both units are unplugged before making any connections.
- Connect the DVD recorder to your TV directly. If you connect the DVD recorder through a VCR, the playback picture will be distorted because DVD video discs are copy protected.
- Connect a cable, etc. signal as described on this page to use the tuner capabilities of this unit and one of the OUT video connections on the CONNECTION pages to play a disc. If your TV only has an RF input, then an RF Modulator Accessory RF-150 will be required.
- After connecting, press the SOURCE button to select TV, "CH" and a channel number will appear on the TV.

CONNECTION-OUT

CONNECTING THE DVD TO A TV USING THE AUDIO/VIDEO OUTPUT JACKS

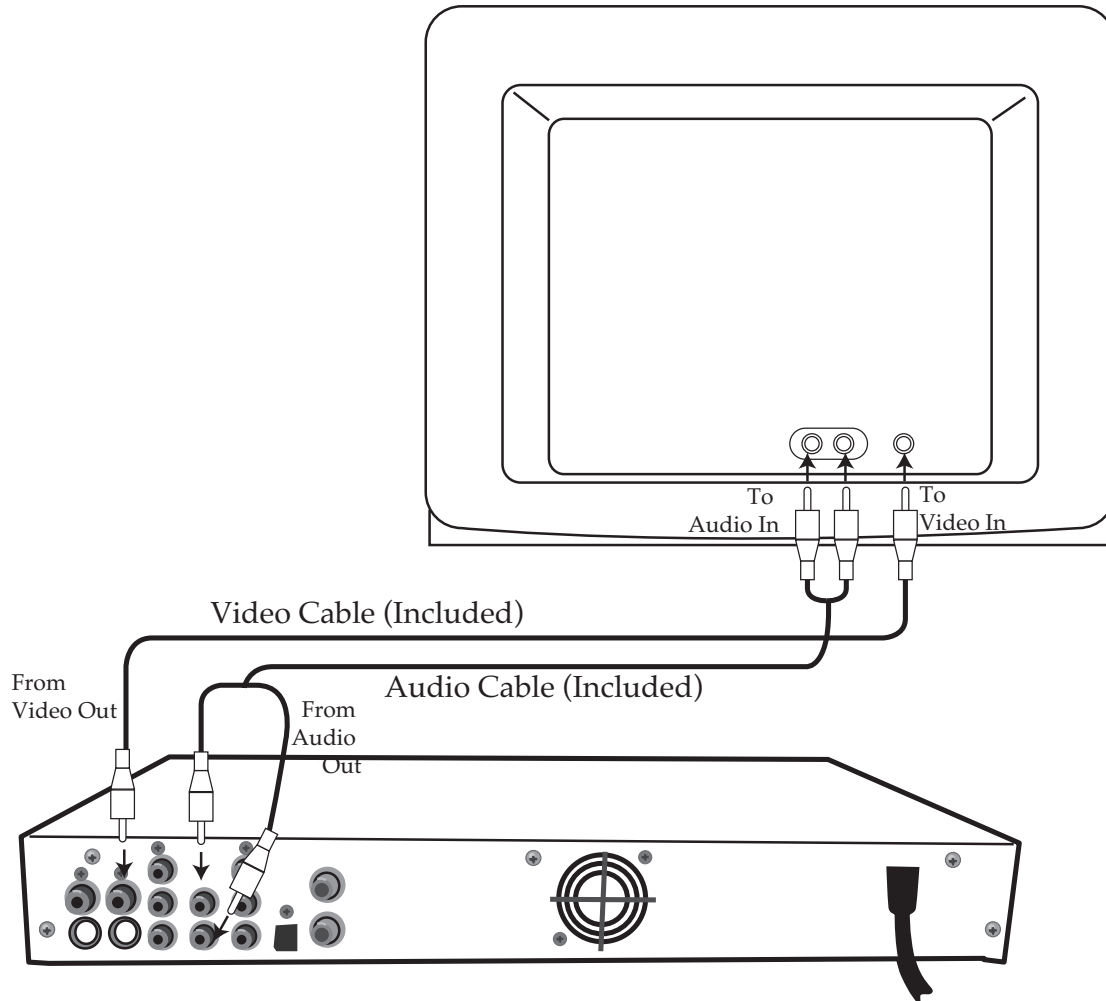

NOTES FOR CONNECTING TO A TV:

- If your TV has a Component input, connect the DVD recorder with the component cable for best results, otherwise use the S-Video or Video OUT jack(s) on the DVD recorder.
- Set the TV's TV/VIDEO button or switch to the VIDEO setting.
- When connecting the DVD, refer to the owner's manual of the TV, as well as this manual.
- When connecting the DVD to the TV, make sure the power is off and both units are unplugged before making any connections.
- If your TV only has one audio input, the use of a "Y" connector may be necessary. Visit your local electronics supply store.
- Connect the DVD recorder to your TV directly. If you connect the DVD recorder through a VCR, the playback picture will be distorted because DVD video discs are copy protected.
- Connect a cable, etc. signal as described on the top of page 9 to use the tuner capabilities of this unit and one of the OUT video connections on the CONNECTION pages to play a disc.

CONNECTION-OUT (CONTINUED)

CONNECTING THE DVD TO A TV USING THE S-VIDEO OUTPUT JACK

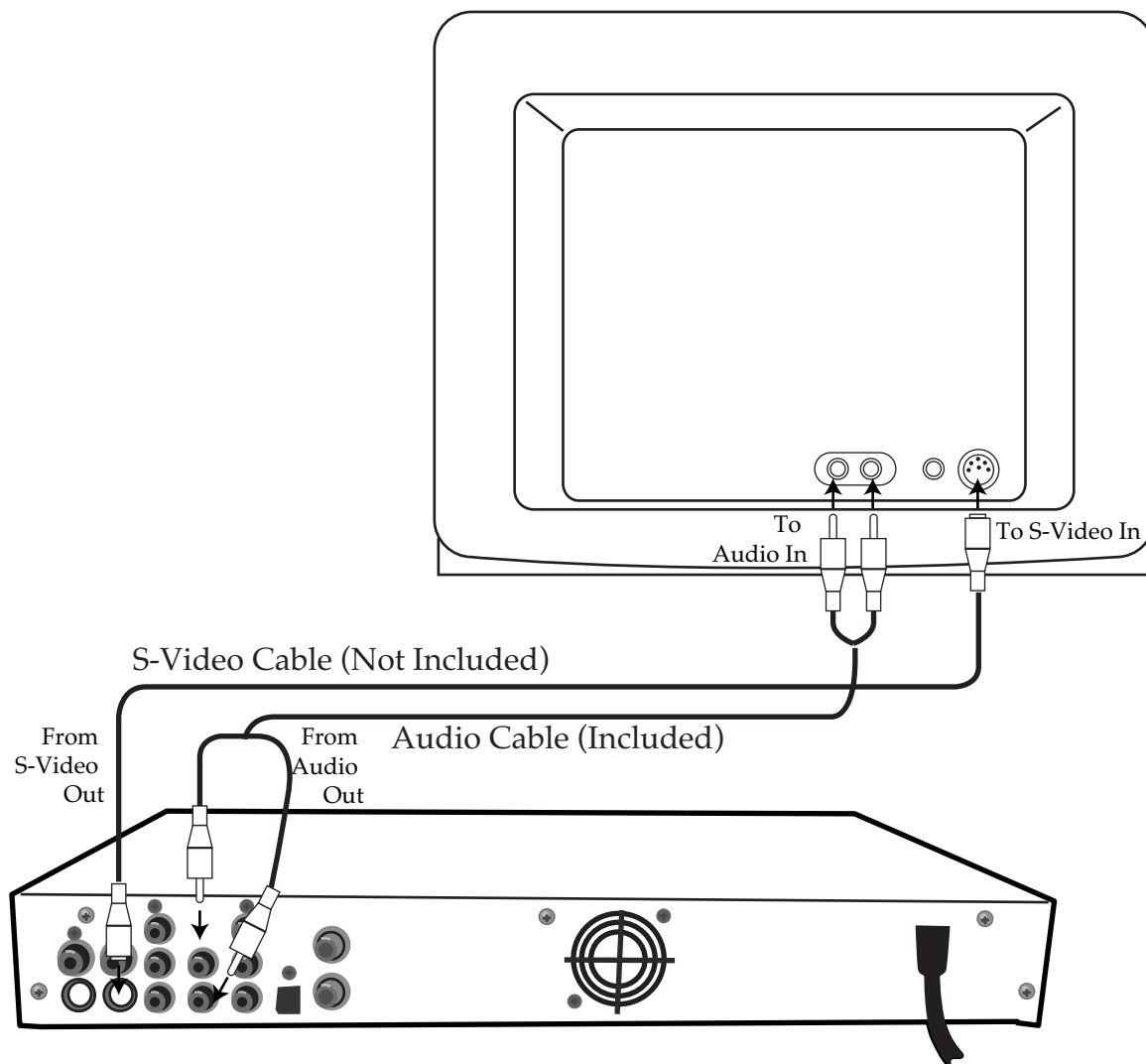

NOTES FOR CONNECTING TO A TV:

- If your TV has a Component input, connect the DVD recorder with the component cable for best results, otherwise use the S-Video or Video OUT jack(s) on the DVD recorder.
- Set the TV's TV/VIDEO button or switch to the VIDEO setting.
- When connecting the DVD, refer to the owner's manual of the TV, as well as this manual.
- When connecting the DVD to the TV, make sure the power is off and both units are unplugged before making any connections.
- If your TV only has one audio input, the use of a "Y" connector may be necessary. Visit your local electronics supply store.
- Connect the DVD recorder to your TV directly. If you connect the DVD recorder through a VCR, the playback picture will be distorted because DVD video discs are copy protected.
- Connect a cable, etc. signal as described on the top of page 9 to use the tuner capabilities of this unit and one of the OUT video connections on the CONNECTION pages to play a disc.
- Do NOT use the yellow video cable when connecting the unit with the S-video cable.

CONNECTION-OUT (CONTINUED)

CONNECTING THE DVD TO A TV USING THE COMPONENT JACKS

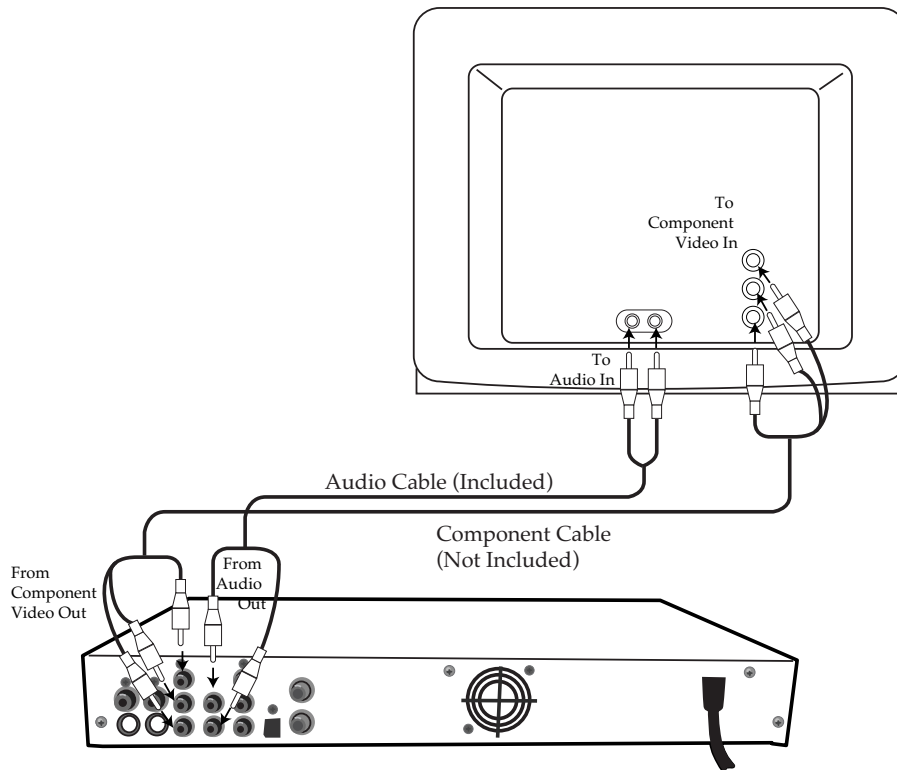

NOTES FOR CONNECTING TO A TV:

- If your TV has a Component input, connect the DVD recorder with the component cable for best results, otherwise use the S-Video or Video OUT jack(s) on the DVD recorder.
- Set the TV's TV/VIDEO button or switch to the VIDEO setting.
- When connecting the DVD, refer to the owner's manual of the TV, as well as this manual.
- When connecting the DVD to the TV, make sure the power is off and both units are unplugged before making any connections.
- Connect the DVD recorder to your TV directly. If you connect the DVD recorder through a VCR, the playback picture will be distorted because DVD video discs are copy protected.
- Connect a cable, etc. signal as described on the top of page 9 to use the tuner capabilities of this unit and one of the OUT video connections on the CONNECTION pages to play a disc.

PROGRESSIVE (YUV) VIDEO OUT:

Use these jacks to connect to a TV with progressive video input jacks. Progressive scan is a video scanning system that displays all lines in a frame in one pass, as opposed to the traditional system, interlaced scan. This connection provides optimum quality. To ensure maximum picture quality, use three video-grade cables for connections. Note that it is essential to match the color-coded connectors with a compatible TV. Press the I/P button on the remote to change between the Progressive and Interlace modes.

525 LINE DIGITAL PROGRESSIVE-SCAN COMPONENT VIDEO OUTPUT

Compared to standard interlaced video, progressive scan effectively doubles the amount of video information fed to your TV or monitor. The result is a stable, flicker-free image. (Check your TV/monitor for compatibility with this feature.)

For the very highest picture quality, try watching a movie on DVD-Video on a progressive-scan compatible TV. While in the Stop mode, press the I/P button on the remote control to switch between Progressive Scan and Interlace Scan or change the settings in the GENERAL setup menu.

NOTE:

- CONSUMERS SHOULD NOTE THAT NOT ALL HIGH DEFINITION TELEVISION SETS ARE FULLY COMPATIBLE WITH THIS PRODUCT AND MAY CAUSE ARTIFACTS TO BE DISPLAYED IN THE PICTURE.

CONNECTION-OUT (CONTINUED)

CONNECTING THE DVD TO A HOME THEATRE SYSTEM

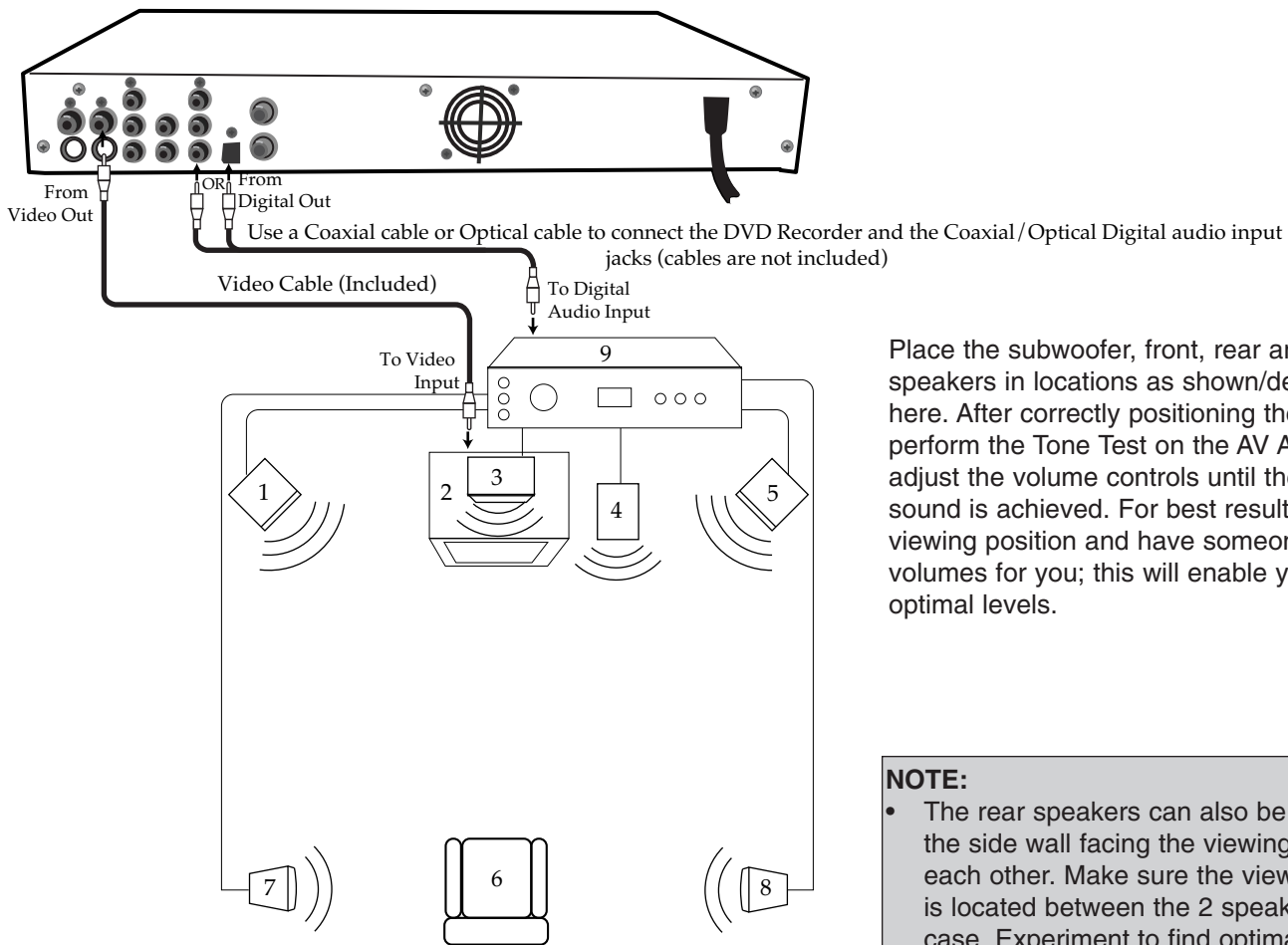

1. Front Left Speaker

2. Television

3. Center Speaker-can be located on top or below the Television.

4. Sub-woofer-can be located anywhere in the room.

5. Front Right Speaker

6. Viewing/Listening Position-The best listening position is obtained by positioning the chair, sofa, etc. in the middle of all the speakers.

7. Rear Left Speaker

8. Rear Right Speaker

9. AV Amplifier w/Dolby Digital Decoder/DTS Decoder

NOTES FOR CONNECTING TO A HOME THEATER SYSTEM:

- If your TV has a Component input, connect the DVD recorder with the component cable for best results, otherwise use the S-Video or Video OUT jack(s) on the DVD recorder.
- Set the TV's TV/VIDEO button or switch to the VIDEO setting.
- When connecting the DVD, refer to the owner's manual for the TV and the audio system, as well as this manual.
- When connecting, make sure the power is off and all units are unplugged before making any connections.
- Connect the DVD recorder to your TV directly. If you connect the DVD recorder through a VCR, the playback picture will be distorted because DVD video discs are copy protected.
- If using a TV with a blue screen option, turn the option off, on the TV for best results.
- If you place the DVD recorder near a tuner, the radio broadcast sound might be distorted. In this case, move the DVD recorder away from the tuner.

CONNECTION-IN

CONNECTING AN EXTERNAL UNIT USING THE AUDIO/VIDEO IN JACKS

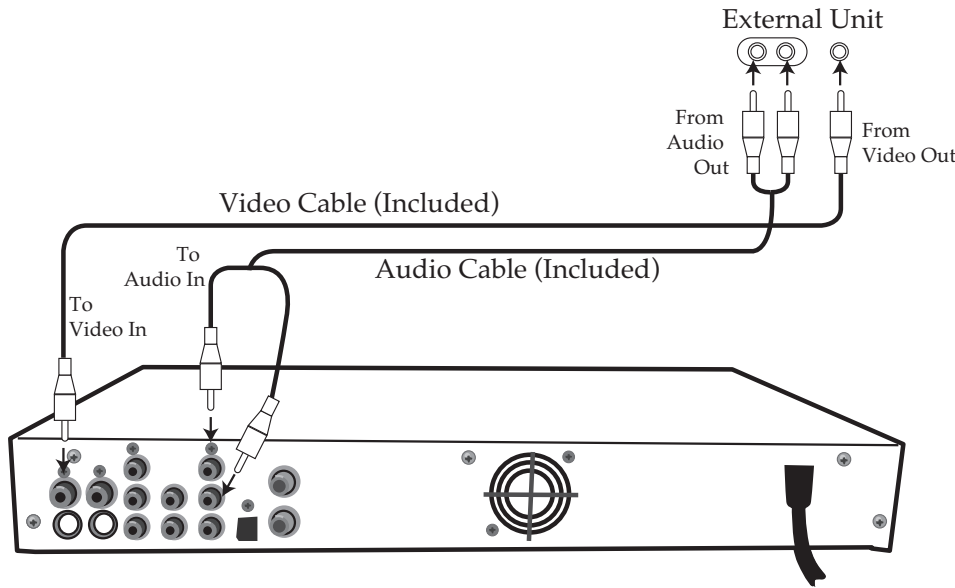

After connecting, plug the AC cord into an AC outlet, then press the Standby button to turn the unit on. Press the SOURCE button repeatedly to select the rear A/V jacks, "R-AV" will appear on the TV.

CONNECTING AN EXTERNAL UNIT USING THE S-VIDEO IN JACK

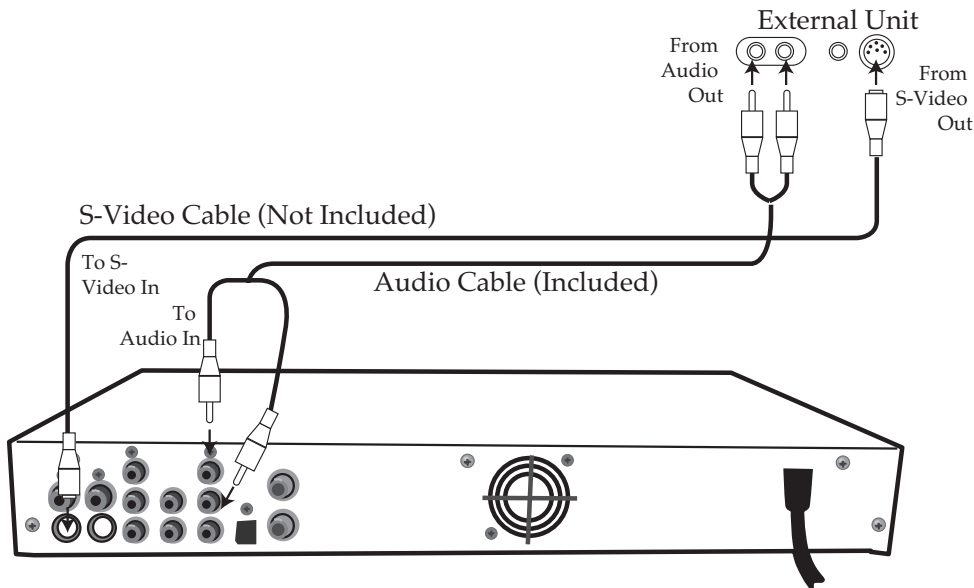

After connecting, plug the AC cord into an AC outlet, then press the Standby button to turn the unit on. Press the SOURCE button repeatedly to select the rear S-VIDEO jacks, "R-SV" will appear on the TV.

NOTES FOR CONNECTING AN EXTERNAL UNIT

- If your External unit has a S-video output, connect the DVD Recorder with the S-Video input jack for best quality, otherwise, use the A/V jacks.
- When connecting the DVD, refer to the owner's manual of the external unit, as well as this manual.
- When connecting the DVD, make sure the power is off and both units are unplugged before making any connections.
- If the external unit only has one audio output, the use of a "Y" connector may be necessary. Visit your local electronics supply store.
- You can also connect the unit to the front jacks for both of the above scenarios as shown on page 15.

CONNECTION-IN (CONTINUED)

CONNECTING AN EXTERNAL UNIT (SUCH AS A DIGITAL CAMCORDER) TO THE DV IN JACK

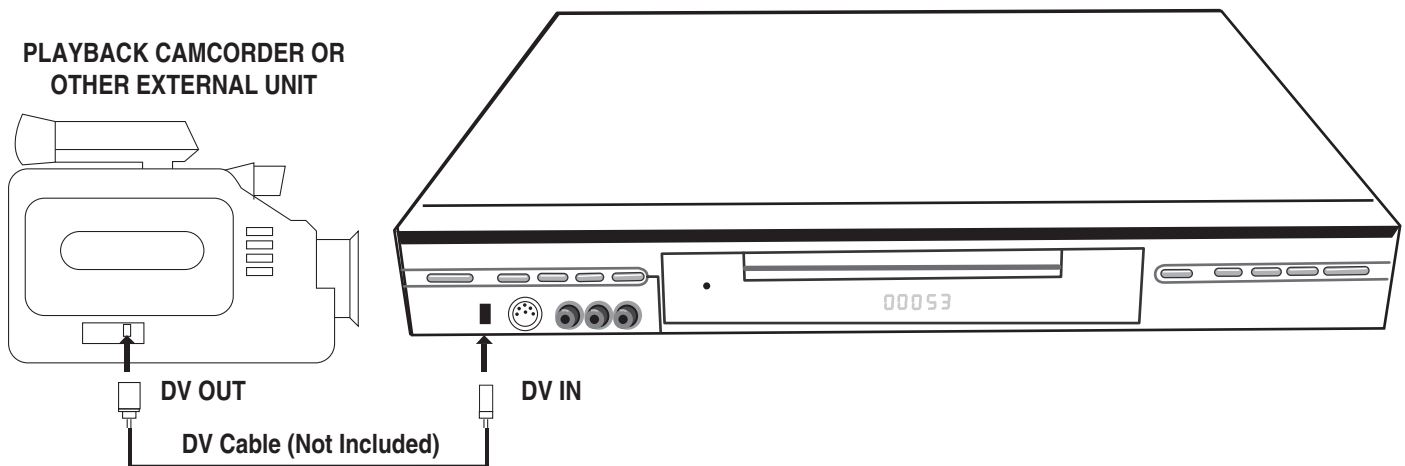

CONNECTING AN EXTERNAL UNIT USING THE FRONT S-VIDEO OR A/V IN JACK(S)

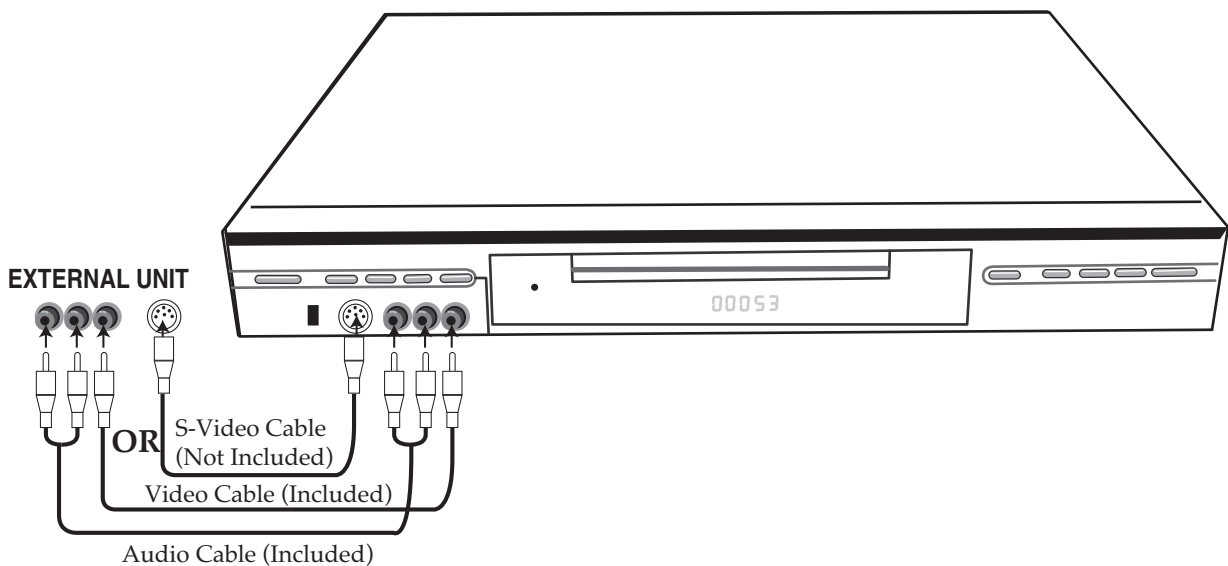

NOTES FOR CONNECTING AN EXTERNAL UNIT

- If your External unit has a S-video output, connect the DVD Recorder with the S-Video input jack for best quality, otherwise, use the A/V jacks.
- The DV IN connection will provide the best quality, followed by the S-Video and then the A/V jacks.
- When connecting the DVD, refer to the owner's manual of the external unit, as well as this manual.
- When connecting the DVD, make sure the power is off and both units are unplugged before making any connections.
- After connecting, plug the AC cord into an AC outlet, then press the Standby button to turn the unit on. Press the SOURCE button repeatedly to select the DV IN jack, "DV" will appear on the TV.
- After connecting, plug the AC cord into an AC outlet, then press the Standby button to turn the unit on. Press the SOURCE button repeatedly to select the front S-Video in jack, "F-SV" will appear on the TV.
- After connecting, plug the AC cord into an AC outlet, then press the Standby button to turn the unit on. Press the SOURCE button repeatedly to select the front Audio/Video IN jack, "F-AV" will appear on the TV.
- If the external unit only has one audio output, the use of a "Y" connector may be necessary. Visit your local electronics supply store.

ABOUT DISCS

The region number for this DVD recorder is:
See the following page for information regarding region numbers.



PLAYABLE DISCS:

The following discs can be played back on this DVD recorder:



RECORDABLE DISCS :

The Recorder can record with the following discs.



MP3

When playing an MP3, the TV screen will list the folders/tracks

MP3 is the abbreviation of "MPEG1 Audio Layer 3". MPEG Audio is a format that compresses the audio portion only.

IMPORTANT NOTES:

Due to many variables, including recording condition, type of disc, writing software, etc., this unit does not guarantee playback of all MP3 discs.

DISC TYPES:

DVD

Data on most DVDs is divided into sections called "titles" and then into subsections called "chapters", each of which is given a title or chapter number. Some features of this DVD recorder will not operate with some DVD discs as they are preset. If a function you selected does not run as desired, refer to the manual accompanying the DVD disc.

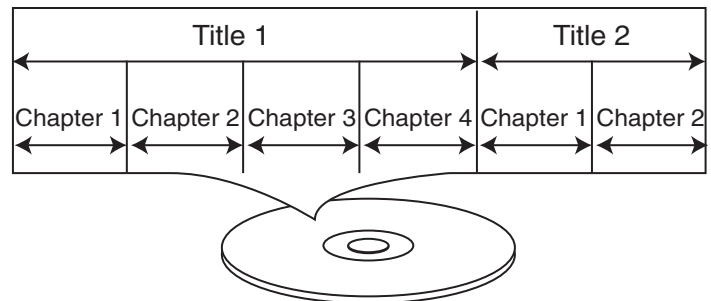

AUDIO CD

Data on an audio CD is divided into sections called "tracks", each of which is given a track number.

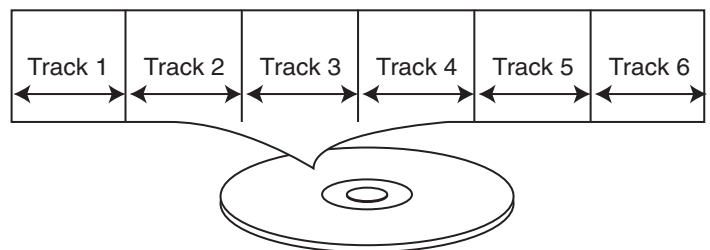

KODAK PICTURE CD

Data on a Kodak picture CD is usually not divided into separate folders, they should appear in the root directory.

IMPORTANT:

It is important that you read the manual that accompanies the DVD disc, as there are features that are on the DVD recorder that cannot be used with certain DVDs. There are also extra features on the DVD disc that are different for each DVD disc, so they are not explained in this owner's manual.

This RECORDER is only be used in NTSC system.

ABOUT DISCS (CONTINUED)

Notes on Copyright:

It is forbidden by law to copy, broadcast, show, broadcast on cable, play in public and rent copyrighted material without permission. DVD video discs are copy protected, and any recordings made from these discs will be distorted. This product incorporates copyright protection technology that is protected by method claims of certain U.S. patents and other intellectual property rights owned by Macrovision Corporation and other rights owners. Use of this copyright protection technology must be authorized by Macrovision Corporation, and is intended for home and other limited viewing uses only, unless otherwise authorized by Macrovision Corporation. Reverse engineering or disassembly is prohibited.

Region Management Information:

This DVD recorder is designed and manufactured to respond to the Region Management Information that is recorded on a DVD disc. If the Region number described on the DVD disc does not correspond to the Region number of this DVD recorder, this DVD recorder cannot play that disc. You may not be able to play back some DVD video discs on this player if they were purchased from outside your geographic area or made for business purposes. When you try to play back an unauthorized disc, "Wrong Region" appears on the TV screen.

FAQs

What is the difference between a DVD+R and DVD+RW?

A DVD+R (Recordable DVD) can only be recorded on once and a DVD+RW (Rewriteable) can be recorded on over one thousand times.

Can I use a DVD cleaning disc?

No, you cannot use a DVD cleaning disc in DVD recorders as the optical unit (laser) operates at a higher power than DVD or CD players and may damage the unit.

SETUP MENU

The setup menu lets you customize the DVD recorder by allowing you to select various preferences.

Below, find the menu, and then find the corresponding page that describes the features of the selected menu option.

1. While in the Stop mode, press the SETUP button **1** to enter the Setup Menu.
2. Select one of the Setup icons at the top of the screen using the Navigation (**◀, ▶**) buttons **2**, then press the ENTER button **3** to select it.
3. Use the Navigation (**▲, ▼, ◀, ▶**) buttons **2** to select one of the setup options, then press the ENTER button **3** to select it. (**Note:** Some settings can only make changed by pressing the ENTER button.)
4. Use the Navigation (**▲, ▼**) buttons **2** to select the desired setting or use the Number buttons to enter the number of the setting, then press the ENTER button **3** to make the change. Press the Navigation (**▲**) button **2** repeatedly to return to the Setup icons and press the SETUP button **1** to exit setup.

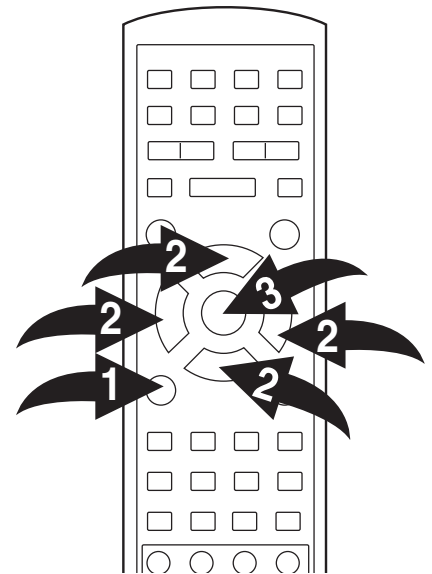

NOTE: Access the Setup menu while in the stop mode, otherwise you may not be able to adjust some settings.

GNRL	PLAY	REC	LANG	TUNER	CLOCK
General system setup					
General setup					
Screen saver	On	▼	Page 19		
Progressive/Interlace	Interlace	▼	Page 19		
Restore factory settings	OK		Page 19		

GNRL	PLAY	REC	LANG	TUNER	CLOCK
Playback setup					
TV aspect ratio	Pan Scar	▼	Page 20		
Rating level	OFF	▼	Page 20		
Digital audio output	RAW	▼	Page 20		
Closed caption	OFF	▼	Page 20		

GNRL	PLAY	REC	LANG	TUNER	CLOCK
Record setup					
Record setup					
Auto chapter marker	ON	▼	Page 21		
Default source	R-SV	▼	Page 21		
Default quality	SEP	▼	Page 21		

GNRL	PLAY	REC	LANG	TUNER	CLOCK
Language setup					
Language setup					
OSD Language	English	▼	Page 22		
Menu Language	English	▼	Page 22		
Subtitle Language	OFF	▼	Page 22		
Audio Language	English	▼	Page 22		

GNRL	PLAY	REC	LANG	TUNER	CLOCK
Start auto scan channel					
TUNER					
Air	SCAN	CH	Skip	Page 23	
		002	☑	Page 23	
		003	☐	Page 23	
		004	☑		
		005	☑		
		006	☑		
		007	☑		

GNRL	PLAY	REC	LANG	TUNER	CLOCK
Date and time setup					
Date & Time Setup					
Date (mm/dd/yy)	01/01/08	Page 24			
Time (hh:mm:ss)	12:15:25	Page 24			
AM/PM	PM	Page 24			

SETUP MENU (CONTINUED)

GENERAL SETUP MENU:

Select GENERAL SETUP using the Navigation (◀, ▶) buttons, then select/change the setup option as described on page 18.

SCREEN SAVER

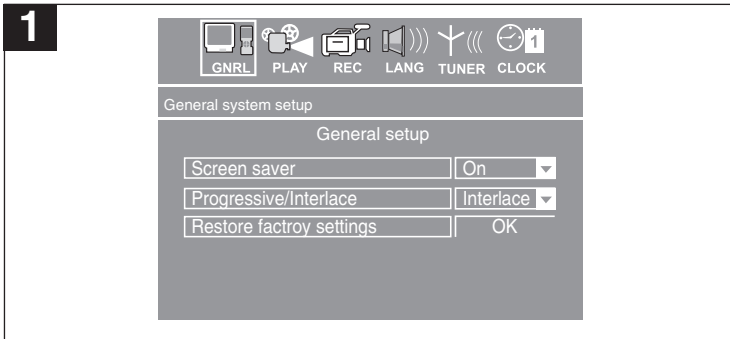

When this option is set to ON, the screen saver will come on when the unit stops for approximately three minutes.
When this option is OFF, the screen saver will not come on.

PROGRESSIVE/INTERLACE

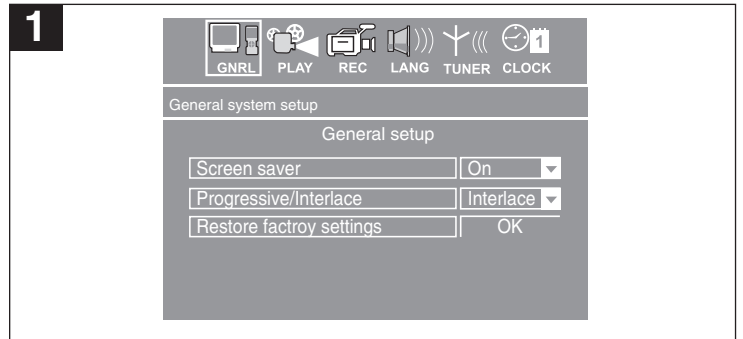

PROGRESSIVE: Select Progressive when connected to the Component jacks for a more stable, flicker free picture.

INTERLACE: Select Interlace when connecting via other methods.

You can also use the I/P button on the remote to select the Progressive or Interlace modes.

RESTORE FACTORY SETTINGS

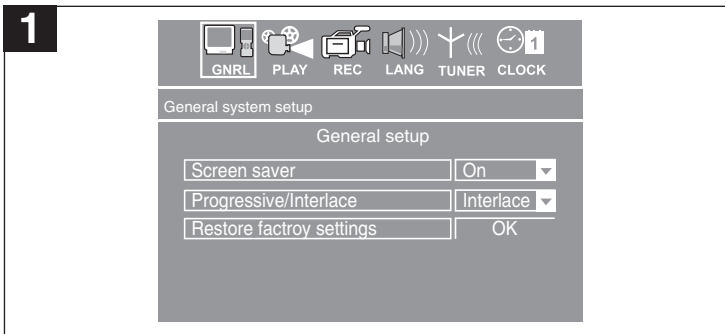

Select RESTORE FACTORY SETTINGS, then press the ENTER button to restore the DVD to its factory settings.

SETUP MENU (CONTINUED)

PLAY SETUP MENU:

Select PLAY SETUP using the Navigation (◀,▶) buttons, then select/change the setup option as described on page 18.

TV ASPECT RATIO

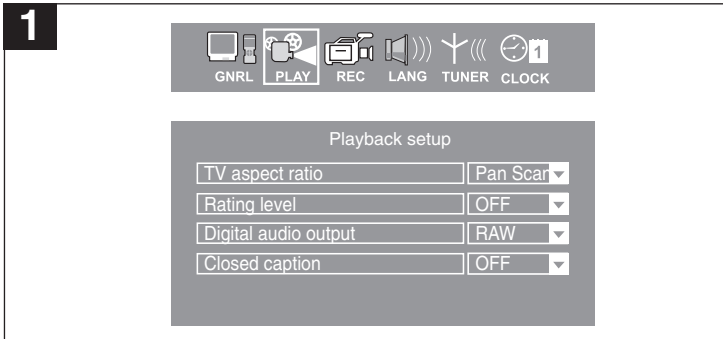

16:9: Select when the unit is connected to a wide-screen TV.

PAN SCAN: Select when the unit is connected to a conventional TV. Video material formatted in the Pan Scan style is played back in that style (the left and right edges are cut off).

LETTERBOX: Select when the unit is connected to a normal TV. Wide-screen images are shown on the screen with a black band at the top or bottom.

RATING LEVEL

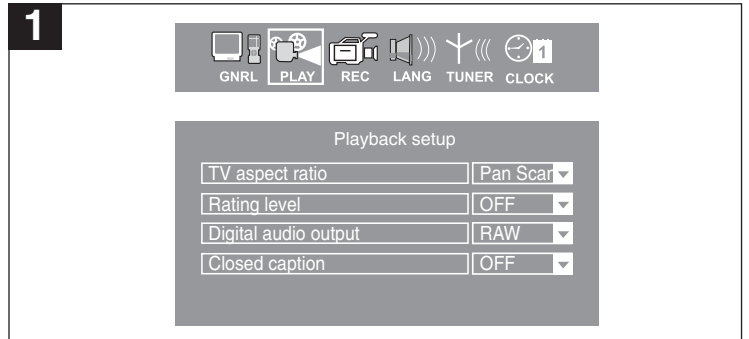

Select ON to turn the Rating Level on and to select a level. Select OFF to turn the Rating Level off.

See page 25 for details.

DIGITAL AUDIO OUTPUT

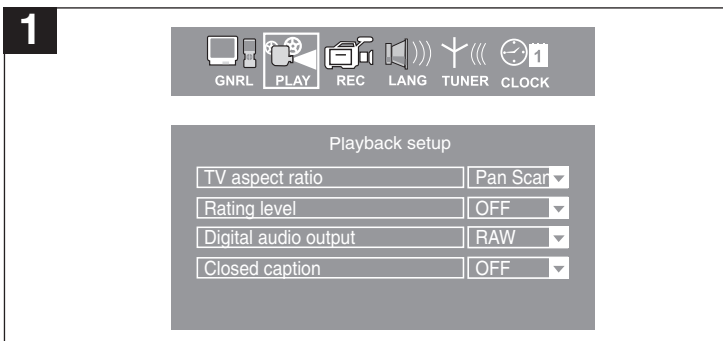

RAW: Select to hear the Digital Output in RAW format.

LPCM: Select to hear the Digital Output in LPCM format.

NOTE: Use a Coaxial cable or Optical cable to connect the DVD Recorder and the Coaxial/Optical Digital audio input jacks (cables are not included).

CLOSED CAPTIONS

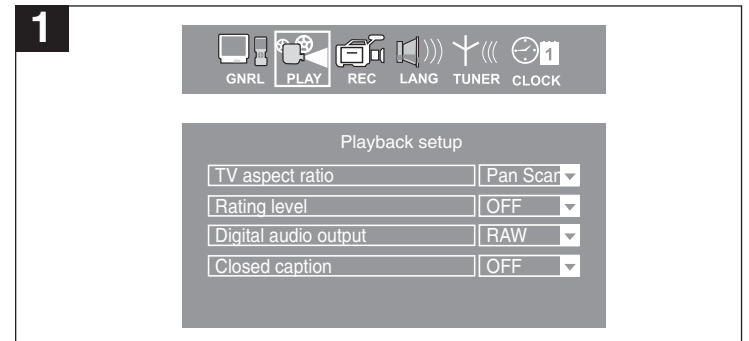

When this option is set to ON, closed captions will appear on the screen for the hearing impaired (if originally recorded on the DVD). When this option is OFF, the closed captions will not appear.

SETUP MENU (CONTINUED)

RECORD SETUP MENU:

Select RECORD SETUP using the Navigation (◀, ▶) buttons, then select/change the setup option as described on page 18.

AUTO CHAPTER MARKER

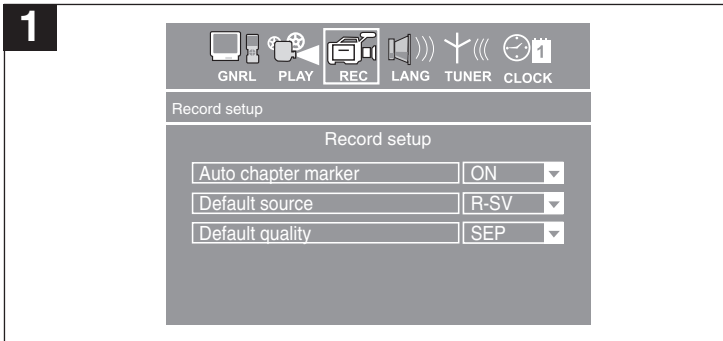

Select ON to turn the Auto Chapter Marker on. Select OFF to turn the Auto Chapter Marker off.

When the Auto Chapter Marker option is set to ON, after every five minutes, a chapter marker (beginning of a chapter) is inserted during the recording.

DEFAULT SOURCE

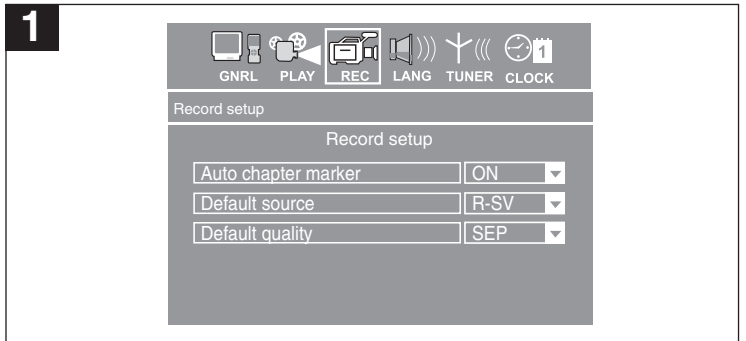

Select the default source (TUNER, F-A/V, F-SV, R-A/V, R-SV or DV).

DEFAULT QUALITY

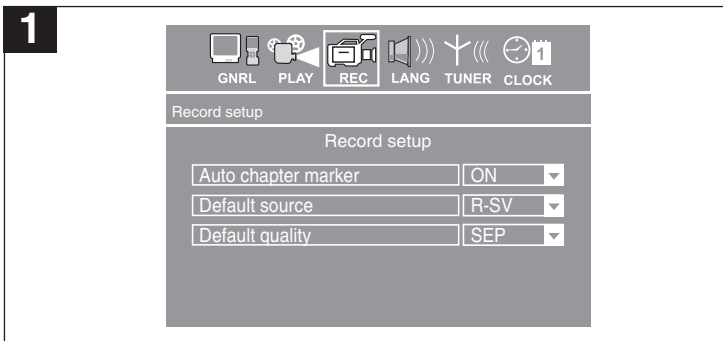

Select the default recording quality:

- SLP:** Super Long Play (good quality).
- EP:** Extended Play (great quality)
- SP:** Standard Play (better quality)
- HQ:** High Quality (best quality)

SETUP MENU (CONTINUED)

LANGUAGE SETUP MENU:

Select LANGUAGE SETUP using the Navigation (◀, ▶) buttons, then select/change the setup option as described on page 18.

OSD LANGUAGE

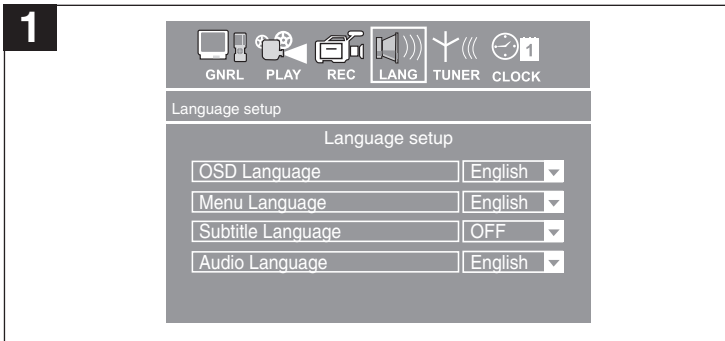

Select the desired language (ENGLISH, SPANISH, FRENCH, GERMAN) for the On-Screen display to display text. Note that the DVD must have the language included in order to display it.

MENU LANGUAGE

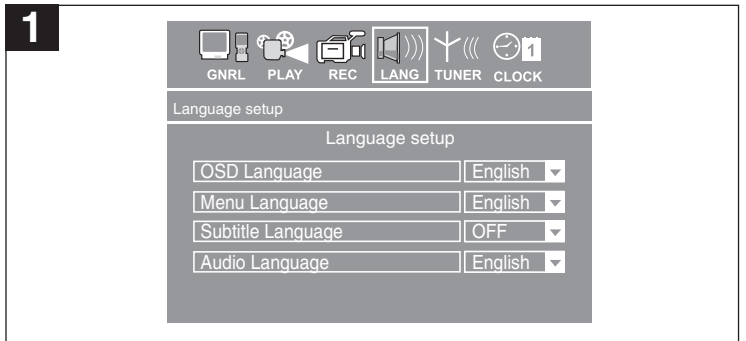

Select the language the DISC MENU will be in (ORIGINAL {original recorded language}, ENGLISH, CHINESE, DANISH, GERMAN, SPANISH, FRENCH, HINDI, HUNGARIAN, INDONESIA, ITALIAN, JAPANESE, KOREAN, MONGOLIAN, MALAY, POLISH, PORTUGUESE, ROMANIAN, RUSSIAN, SLOVAK, SWEDISH, THAILAND, TURKISH, VIETNAMESE, NORWEGIAN, FINNIC). The DVD's DISC MENU must be made in the selected language, otherwise the default language of the DVD will be shown.

SUBTITLE LANGUAGE

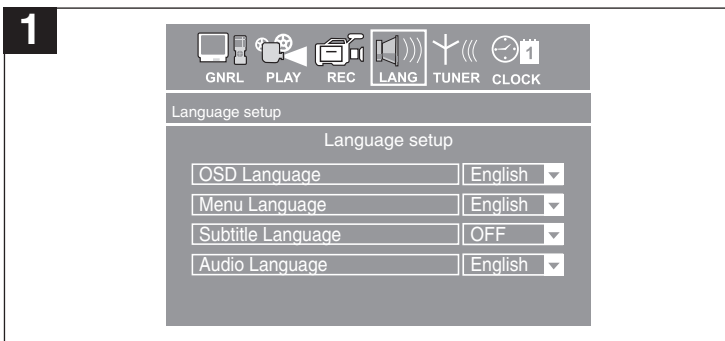

Select the language the Subtitle (OSD) will be in (ORIGINAL {original recorded language}, ENGLISH, CHINESE, DANISH, GERMAN, SPANISH, FRENCH, HINDI, HUNGARIAN, INDONESIA, ITALIAN, JAPANESE, KOREAN, MONGOLIAN, MALAY, POLISH, PORTUGUESE, ROMANIAN, RUSSIAN, SLOVAK, SWEDISH, THAILAND, TURKISH, VIETNAMESE, NORWEGIAN, FINNIC, OFF). The DVD must be recorded in the selected language, otherwise the default language of the DVD will be shown. Select OFF to select without any language showing on the screen.

AUDIO LANGUAGE

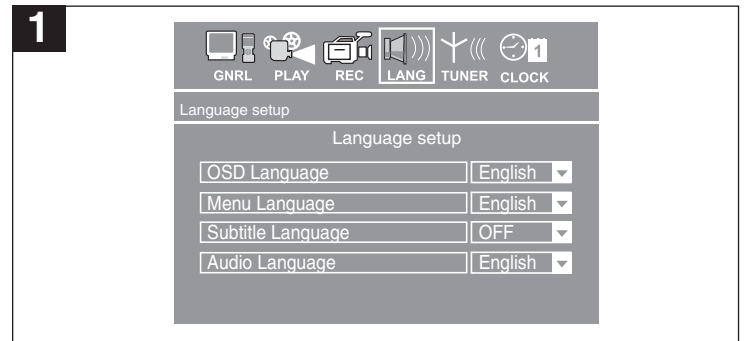

Select the language the DVD will be played back in (ORIGINAL {original recorded language}, ENGLISH, CHINESE, DANISH, GERMAN, SPANISH, FRENCH, HINDI, HUNGARIAN, INDONESIA, ITALIAN, JAPANESE, KOREAN, MONGOLIAN, MALAY, POLISH, PORTUGUESE, ROMANIAN, RUSSIAN, SLOVAK, SWEDISH, THAILAND, TURKISH, VIETNAMESE, NORWEGIAN, FINNIC). The DVD must be recorded in the selected language, otherwise the default language of the DVD will be played.

SETUP MENU (CONTINUED)

TUNER SETUP MENU:

Select TUNER SETUP using the Navigation (◀,▶) buttons, then select/change the setup option as described on page 18. This unit is equipped with a channel memory feature which allows channels to skip up or down to the next channels set into memory, skipping over unwanted channels. Before selecting channels, they must be programmed into the unit's memory. In addition to normal VHF/UHF channels, this unit can receive up to 125 Cable TV channels. First set the AIR/CABLE option, then follow the steps in Auto Channel scan below.

SETTING AIR/CABLE OPTION

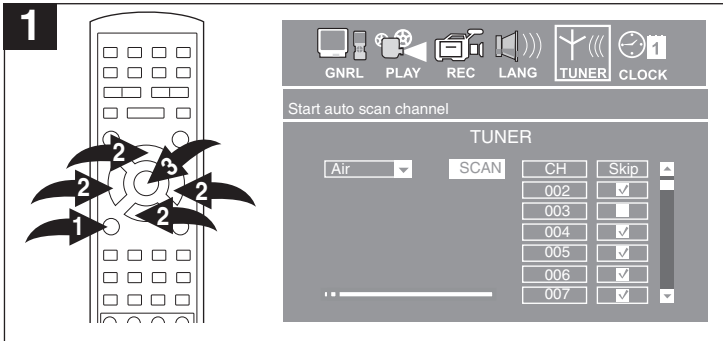

Press the SETUP button ❶ to enter the Setup Menu. Select the TUNER Setup icon at the top of the screen using the Navigation (◀,▶) buttons ❷, then press the ENTER button ❸ to select it. Press the ENTER button ❸ again to select the Air/Cable pull down menu. Select AIR or CABLE using the Navigation (▲,▼) buttons ❹, then press the ENTER button ❸. Select CABLE if using cable television or AIR if using an outdoor antenna.

AUTO CHANNEL SCAN

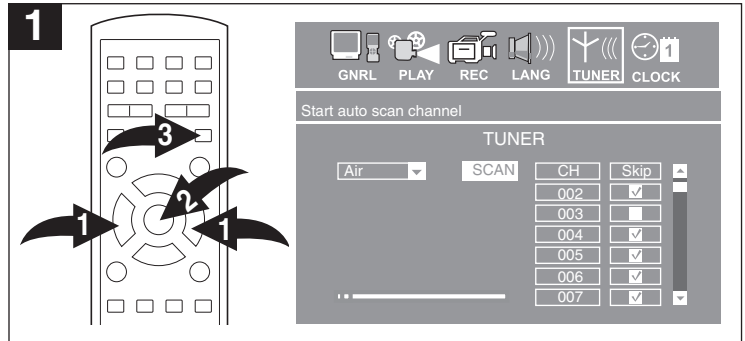

Follow the steps in Setting Air/Cable Option, then select SCAN using the Navigation (◀,▶) buttons ❶ followed by the ENTER button ❷; the unit will then automatically cycle through all the channels and store active channels into memory. All non-active channels will be marked with a check in the Skip column.

NOTES:

- During Auto Scan, press the Stop (■) button ❸ to cancel searching.
- It is highly recommended to perform the Auto Channel Scan to scan all channels and store the active channels into memory when first using the set. The "TUNER" option may not be available if no channel or station is found.

ADDING/SKIPPING CHANNELS

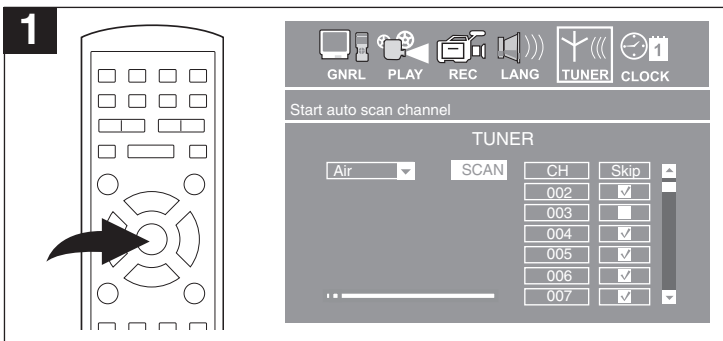

After setting channels into memory, you can add or skip channels. Scroll to the Skip column and you will see that all skipped channels have a check next to them. To add or skip a channel, simply select the check box next to the channel number and press the ENTER button to skip (a checkmark will appear) or add (a checkmark will disappear).

ADDING/SKIPPING CHANNELS NOTE:

To View the channel, use the Navigation (◀,▶,▲,▼) button to select the CH number, then use the Number buttons to enter the desired channel number (or use the Navigation ▲,▼ button to select the desired channel). Press the ENTER button to view that channel under the setup menu on the TV screen.

SETUP MENU (CONTINUED)

CLOCK SETUP MENU:

Select CLOCK SETUP using the Navigation (◀, ▶) buttons, then select/change the setup option as described on page 18.

SETTING THE CLOCK

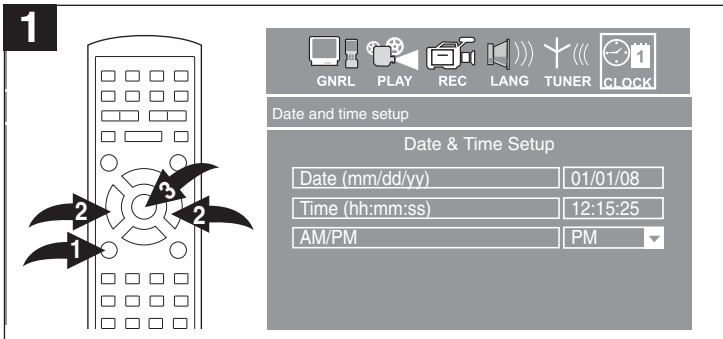

Press the SETUP button ❶ to enter the Setup Menu. Select the CLOCK Setup icon at the top of the screen using the Navigation (◀, ▶) buttons ❷, then press the ENTER button ❸ to select it.

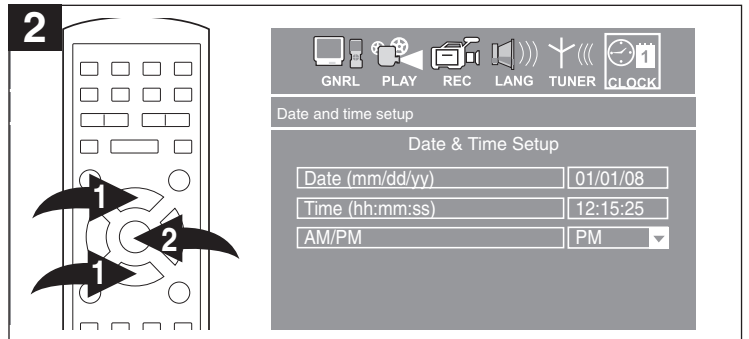

Select Date using the Navigation (▲, ▼) buttons ❶, then press the ENTER button ❷ to select it.

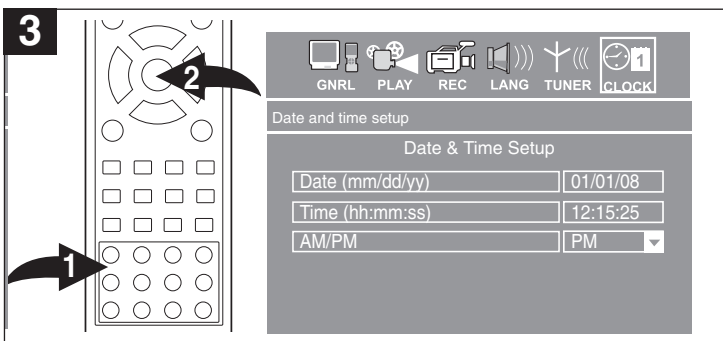

Select the two digits of the month, then the day, then the year using the number buttons ❶.

NOTE: Two digits must be pressed for each, for a total of 6 digits.

Press the ENTER button ❷ to confirm; if entered correctly, "DATE INPUT SUCCESS" will appear at the top of the screen.

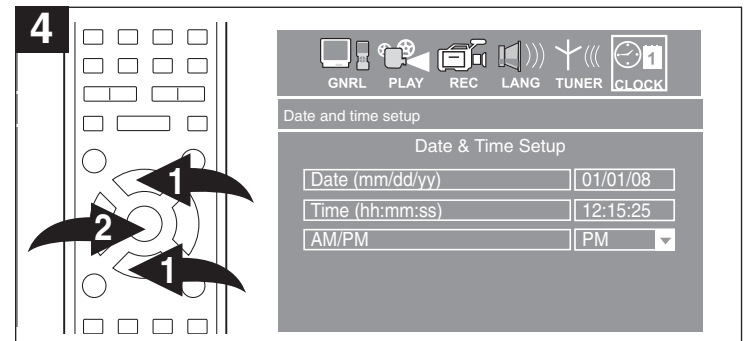

Repeat steps 2 and 3 to set the current time, making sure to enter six digits (two for the hours, two for the minutes and two for the seconds).

Select the AM/PM pull-down menu using the Navigation (▲, ▼) buttons ❶, then press the ENTER button ❷ to select it. Select AM or PM using the Navigation (▲, ▼) buttons ❶, then press the ENTER button ❷ to confirm; "TIME INPUT SUCCESS" will appear at the top of the screen.

SETUP MENU (CONTINUED)

SETTING THE RATING LEVEL

The Rating Level enables parents to prevent their children from watching inappropriate material on a DVD. It reads the ratings for programming, then denies access to programming if the program's rating meets the limitations you select. In this case, the user will have to enter a password.

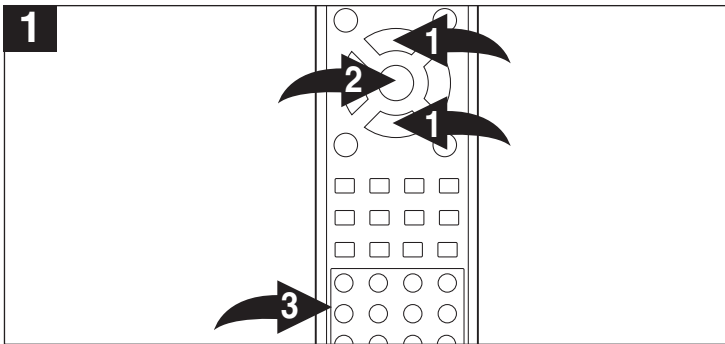

At the PLAY SETUP MENU, use the Navigation (▲,▼) buttons ❶ to select RATING. Press the ENTER button ❷ and then enter your password using the number buttons ❸. The password is "1234", unless it was changed in the CHANGING THE PASSWORD section below. Press the ENTER button ❷ again; the Set Rating Level screen will appear.

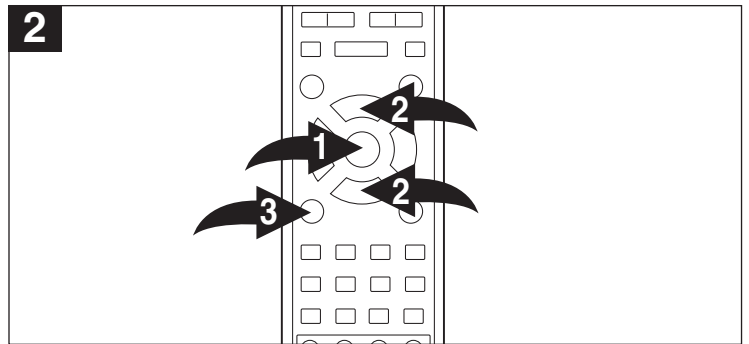

Press the ENTER button ❶, followed by the Navigation (▲,▼) buttons ❷ to select the desired rating as follows:

1 (KIDSAFE): Kidsafe.	6 (R): Under 17 years old, Parental Guidance strongly suggested.
2 (G): All ages.	7 (NC17): 17 years old and above.
3 (PG): Parental Guidance.	8 (ADULT): Adult only.
4 (PG13): Parental Guidance less than 13 years old.	OFF: Select OFF if you do not want to set a rating.
5 (PGR): Under 17 years old, Parental Guidance suggested.	

Press the ENTER button ❶ again to confirm. Press the SETUP button ❸ to exit the setup menu or select "OK", then press the ENTER button ❶ to exit the setting the Rating Level screen.

CHANGING THE PASSWORD

Select this option to change the password.

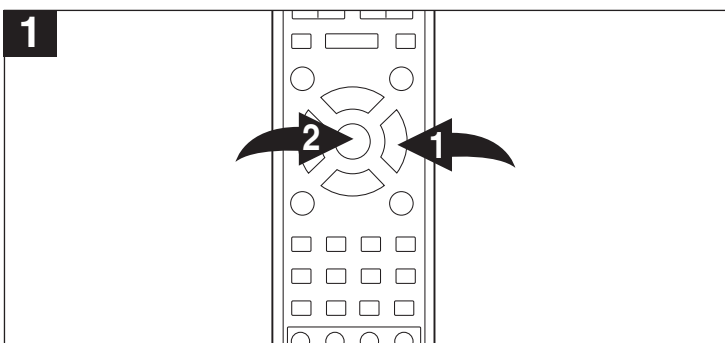

Follow step 1 above. Select NEW using the Navigation (▶) button ❶, then press the ENTER button ❷.

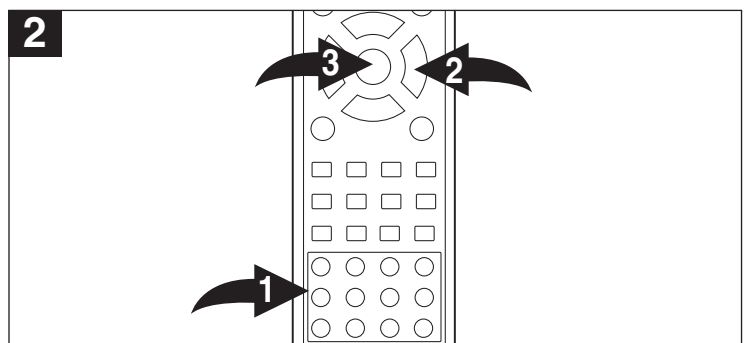

Enter the New Password using the Number buttons ❶, then press the Navigation button (▼) ❷ to access the Confirm Password field. Enter the New Password again using the Number buttons ❶, then press the ENTER button ❸; the new password will be set, make sure to write it down.

TV OPERATION

1

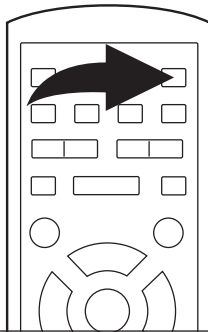

Press the ON/STANDBY button to turn on the unit; the STANDBY indicator will go out.

2

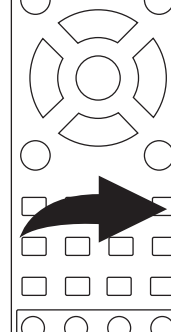

Press the SOURCE button to select TV, "CH" and a channel number will appear on the TV

3

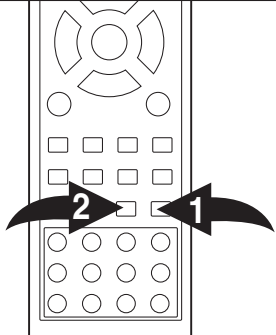

Adjust the volume level by pressing the VOLUME Up ❶ or Down ❷ button. The volume level will be indicated by a bar on the bottom of the screen.

4

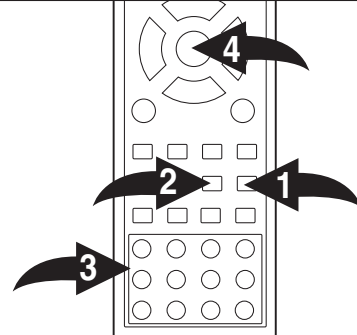

For proper operation, before selecting channels, they must be set into the TV's program memory, see page 23. Press and release the CHANNEL Up ❶ or Down ❷ button. The TV automatically stops at the next channel set into memory. This will not operate if channels are not set into memory.

Direct Program Selection buttons (0 - 9)

Use these buttons to select a channel. The channel number will appear at the top left corner of the screen.

- Select a channel using the Number buttons ❸ followed by the ENTER button ❹.

NOTES:

- When AIR/CABLE option is set to AIR, only channels from 002 to 069 can be selected. When set to CABLE, channels up to 125 can be selected.
- If an invalid channel is selected, the display will revert to the original channel.

FAQs:

Why do I only receive up to channel 69, when my cable goes much higher?
AIR/CABLE menu option must be set to CABLE when using cable, see page 23.

Why are some channels scrambled?
You must subscribe to these channels through your cable company.

DVD BASIC OPERATION

IMPORTANT:

When “INVALID” appears while pressing a button, this means that the corresponding function cannot be performed either on the disc inserted, or in the selected mode.

DISPLAY BUTTON (DVD MODE):

While playing a DVD, press the DISPLAY button to view the control options. Press the Navigation (◀,▶) buttons to select the desired icon, then press the ENTER button to select it. Once selected, press the Navigation (▲,▼) buttons or the Number buttons to change the option, then the ENTER button to confirm the change.

When finished, press the DISPLAY button to remove the control options from the TV screen.

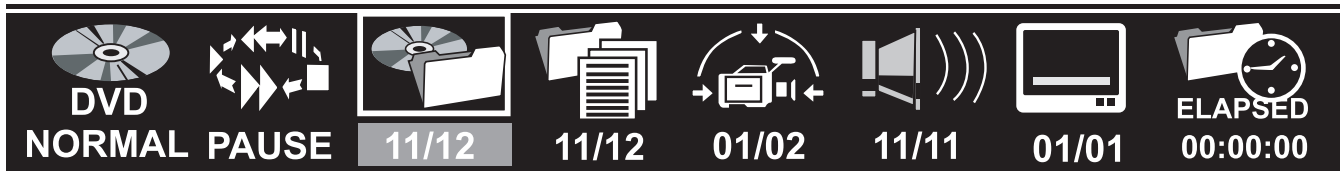

Playback Mode: Select the desired play mode (program, random, etc.).



Playback Control: Select the desired playback control (fast forward, fast reverse, pause, etc.).



Title: Select this option and enter the desired title using the Number buttons. The first number is the current title and the second number is the total titles.



Chapter: Select this option and enter the desired chapter using the Number buttons. The first number is the current chapter and the second number is the total chapters.



Angles: While in the Play mode, select this option and enter the desired angle using the Number buttons. You can also change the setting using the ANGLE button. The first number is the current angle and the second number is the total angles. This is not available on all discs.



Audio Setting: While in the Play mode, select this option and enter the desired audio setting using the Number buttons. You can also change the setting using the AUDIO button. The first number is the current audio setting and the second number is the total audio settings. This is not available on all discs.



Subtitle: While in the Play mode, select this option and enter the desired subtitle using the Number buttons. You can also change the setting using the SUBTITLE button. The first number is the current subtitle and the second number is the total subtitles. “OFF” will appear if no subtitle is selected. This is not available on all discs.



Elapsed Time: The elapsed time will appear. Press the ENTER button to select, enter the desired time to start playback using the Number buttons, then press the ENTER button; the DVD will start playing at the selected time. Press the Navigation (▼) button to view the Remain time of the DVD, press once again to return to show the Elapsed time again.

NOTE: On some discs, you will not be able to select the desired time for playback or to view the Remain time.

DVD BASIC OPERATION (CONTINUED)

IMPORTANT NOTES:

- “INVALID” will appear on the TV screen during operation if you try to access a function that is not available on the disc.
- Some discs may take a few seconds to load.
- If a disc is inserted incorrectly, dirty, damaged, or is not present at all, “NO DISC” will appear in the display.
- Always hold the disc without touching either of its surfaces. When inserting a disc, position it with the printed title side facing up, align it with the guides and place it in its proper position.
- It is important that you read the manual that accompanies the DVD disc as there are features that are on this DVD recorder that cannot be used with certain DVDs. There are also extra features that are different for each DVD disc, so they are not explained in this owner’s manual.
- While the DVD Recorder is in another mode (F-AV,F-SV,R-A/V, etc), press the PLAY (▶) button to change the recorder to DVD mode.

PLAYBACK OF A DVD

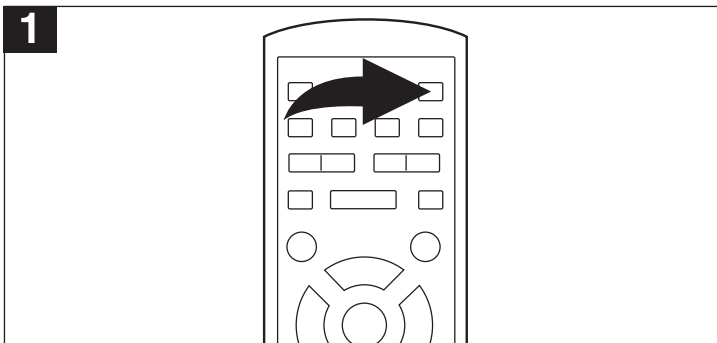

Press the ON/STANDBY button to turn on the unit; the STANDBY indicator will go out.

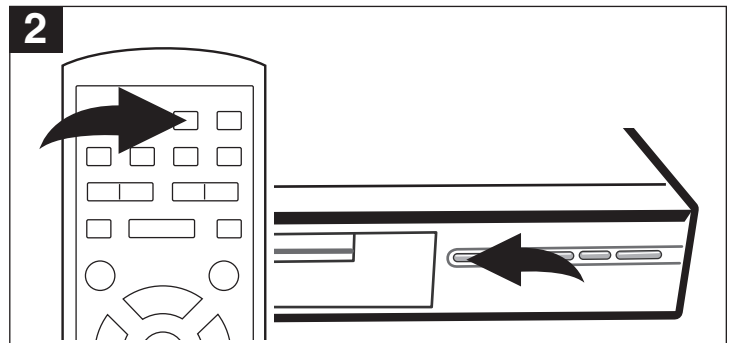

Press the OPEN/CLOSE button to open the disc tray, “OPEN” will appear in the display. Insert a disc with the label side facing up on the disc tray.

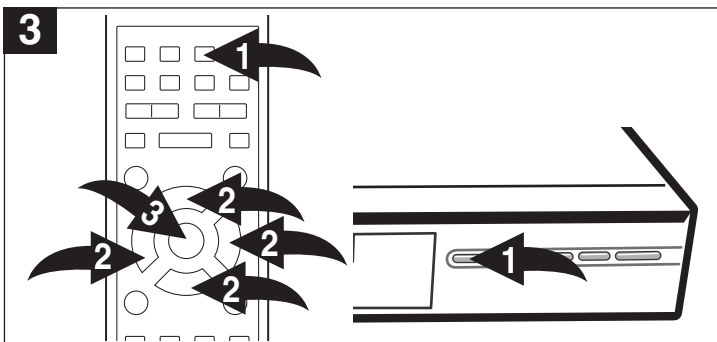

Press the OPEN/CLOSE button ❶ to close the disc tray. “LOAD” will appear on the screen and in the display. After loading, the menu screen of the DVD should appear. Use the Navigation (◀, ▶, ▲, ▼) buttons ❷ to select the desired option and the ENTER button ❸ to select it.

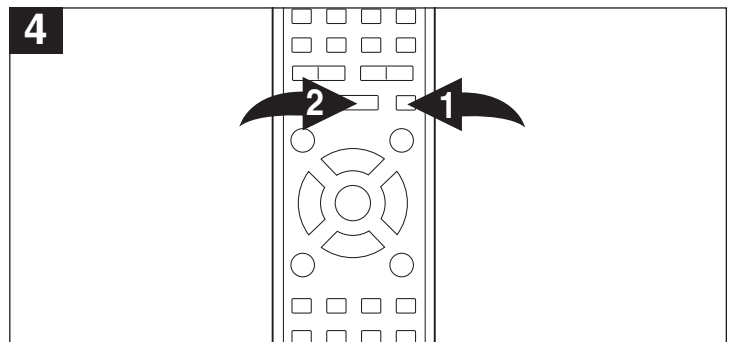

To stop playback, press the STOP (■) button ❶; “PSTOP” (Pre-stop) will appear on the TV screen. Because the unit will remember where you stopped, simply press the PLAY (▶) button ❷ to resume playback where you left off (resuming playback).

If the STOP (■) button ❶ is pressed twice, the TV screen shows “STOP” and the unit will stop completely.

DVD BASIC OPERATION (CONTINUED)

PLAYBACK OF A PRERECORDED DVD+RW OR DVD+R

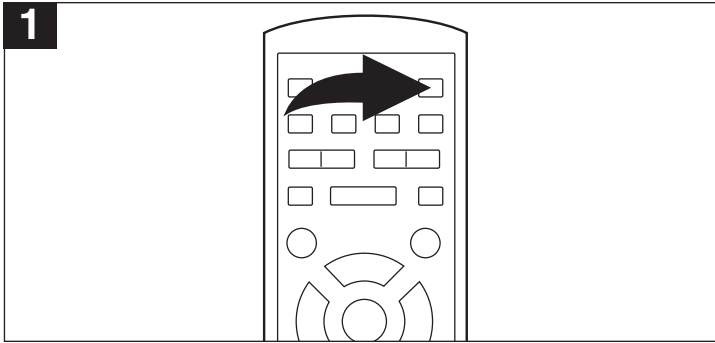

Press the ON/STANDBY button to turn on the unit; the STANDBY indicator will go out.

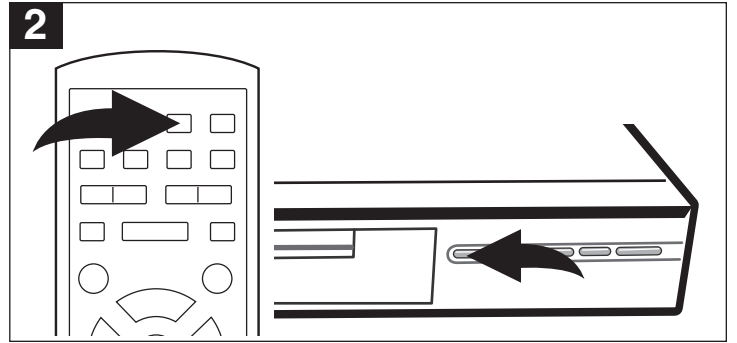

Press the OPEN/CLOSE button to open the disc tray, "OPEN" will appear in the display. Insert a disc with the label side facing up on the disc tray.

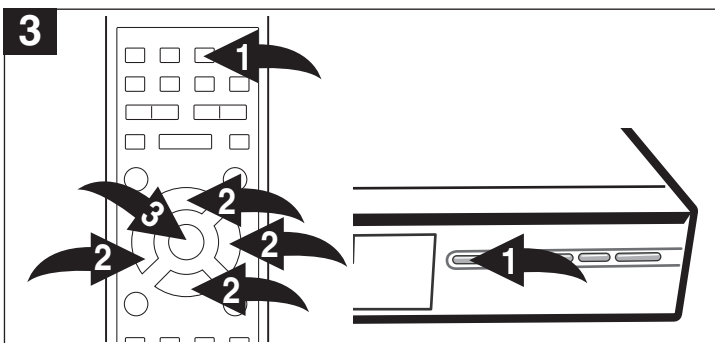

Press the OPEN/CLOSE button ❶ to close the disc tray. "LOAD" will appear on the screen and in the display. After loading, the index screen of the DVD should appear. Use the Navigation (◀, ▶, ▲, ▼) buttons ❷ to select the desired title to play and the ENTER button ❸ to select it; playback will start automatically. Select "NEXT" or "PREV" then press the ENTER button ❸ to turn the index screen to the Previous/Next page of the index.

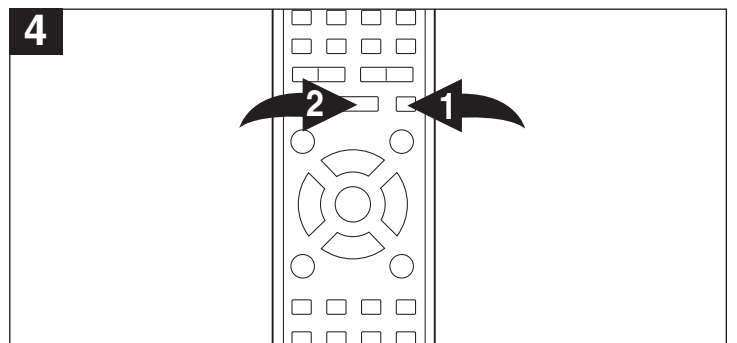

To stop playback, press the STOP (■) button ❶; "PSTOP" (Pre-stop) will appear on the TV screen. Because the unit will remember where you stopped, simply press the PLAY (▶) button ❷ to resume playback where you left off (resuming playback).

If the STOP (■) button ❶ is pressed twice, the TV screen shows "STOP" and the unit will stop completely.

NOTE:

- After finishing playback of all titles, the index screen of the DVD will appear on the TV screen.

DVD BASIC OPERATION (CONTINUED)

SKIP

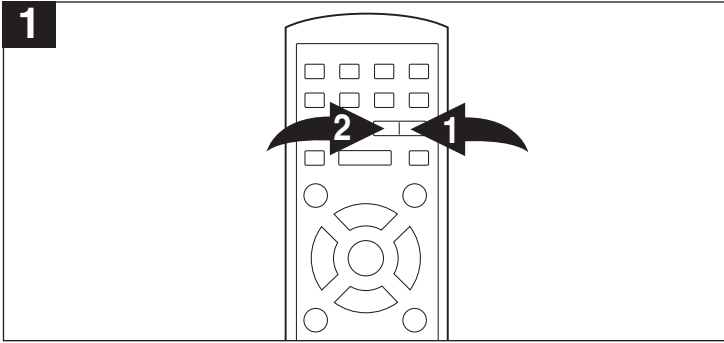

Press the Skip (▶▶) button ❶ to advance the DVD to the beginning of the next chapter.

Press the Skip (◀◀) button ❷ to move the DVD to the beginning of the previous chapters.

SEARCH

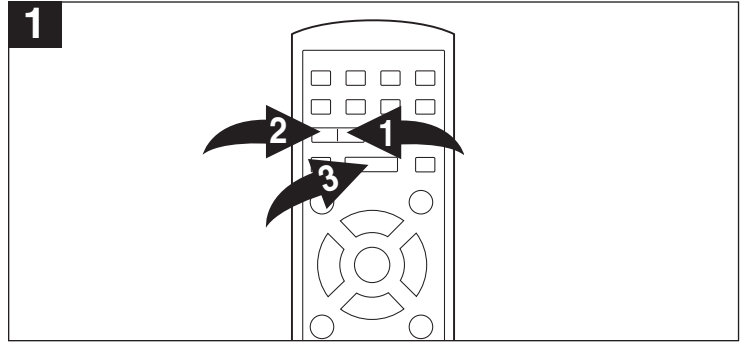

During playback, press either the Search ▶▶ ❶ button or Search ◀◀ ❷ button to move the DVD forward or backward at double (x2) speed to locate a specific section. Repeatedly press these buttons and the speed will increase to x4, x16, , 32 and resume normal playback
The DVD will move forward or backward at high speed until the PLAY (▶) button ❸ is pressed again; normal playback will resume at that point.

SLOW/F

Use this feature to move the DVD in slow motion.

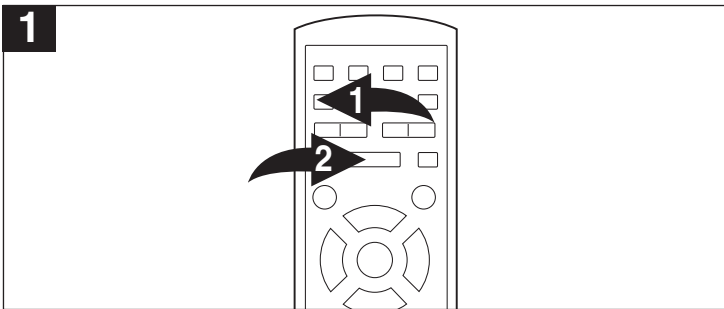

During playback, press either the SLOW button ❶ repeatedly to move the DVD forward in slow motion speeds of 1/2, 1/4 or 1/8. The sound will be muted.
The player will move forward in slow motion until the PLAY (▶) button ❷ is pressed again; normal playback will resume at that point or press the SLOW button ❶ again to resume normal playback.

PAUSE/STEP

Use this feature to pause and/or step frame by frame.

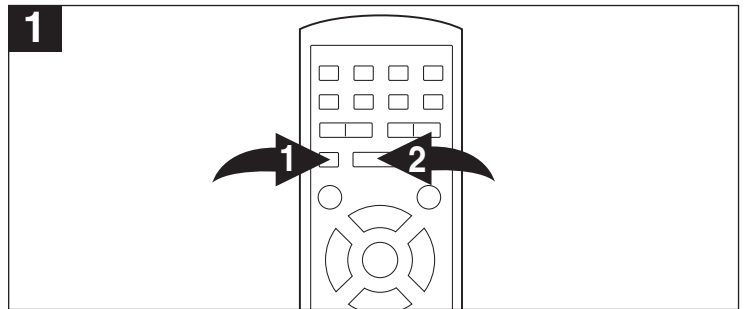

Press the PAUSE/STEP button ❶ once to pause the picture.
Repeatedly press the PAUSE/STEP button ❶ to play the DVD one frame at a time.
Press the PLAY (▶) button ❷ to resume normal playback.

DVD BASIC OPERATION (CONTINUED)

TITLE SEARCH

Use this feature to directly go to a specific title.

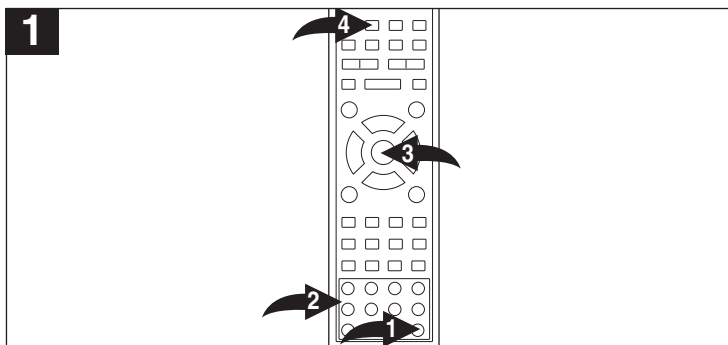

Press the GOTO button ❶ repeatedly until the control options appear on the screen with the Title option highlighted. Use the Number buttons ❷ to select the desired title number, then press the ENTER button ❸; playback will start immediately.

Press the DISPLAY button ❹ to remove the control options from the screen.

CHAPTER SEARCH

Use this feature to directly go to a specific chapter.

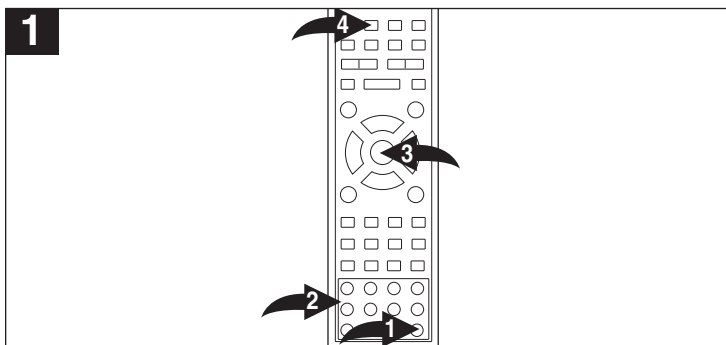

Press the GOTO button ❶ repeatedly until the control options appear on the screen with the Chapter option highlighted. Use the Number buttons ❷ to select the desired chapter number, then press the ENTER ❸ button; playback will start immediately.

Press the DISPLAY button ❹ to remove the control options from the screen.

TIME SEARCH

Use this feature to directly go to a specific time.

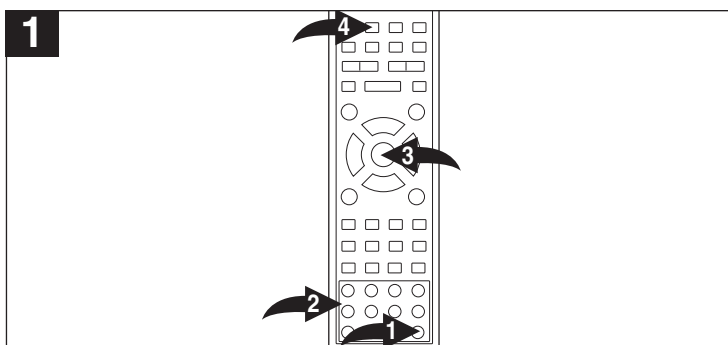

Press the GOTO button ❶ repeatedly until the control options appear on the screen with the Elapsed Time option highlighted. Use the Number buttons ❷ to select the desired time you want to play, then press the ENTER button ❸; playback will start immediately.

Press the DISPLAY button ❹ to remove the control options from the screen.

This feature is not available on DVD+RW or DVD+R discs.

MUTE

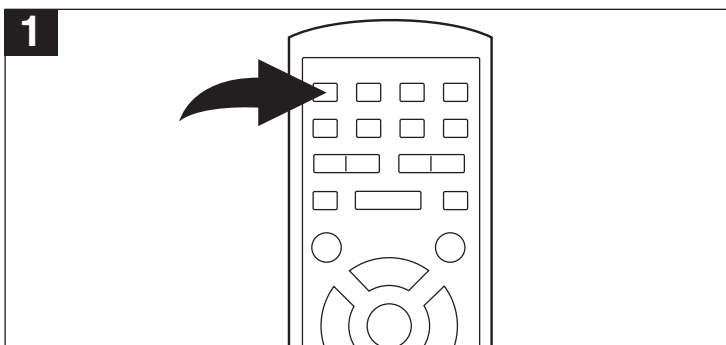

Press the MUTE button to mute the sound; the Mute indicator will appear on the screen. Press the MUTE button again to restore the sound.

DVD BASIC OPERATION (CONTINUED)

REPEAT PLAYBACK

While playing back a DVD, this unit can repeatedly play back a chapter, title or the entire DVD repeatedly.

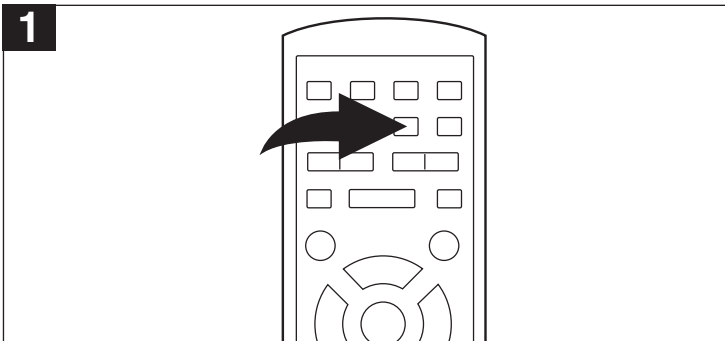

While in the Playback mode, press the REPEAT button once to repeatedly playback the current chapter; "C-RPT" will appear briefly on the screen. Press the REPEAT button a second time to repeatedly playback a title; "T-RPT" will appear on the screen. Press the REPEAT button a third time to repeat the entire DVD; "D-RPT" will appear briefly on the screen. Press the REPEAT button once more to cancel Repeat mode; "NORMAL" will appear briefly on the screen.

A-B REPEAT PLAYBACK

While playing back a DVD, this unit can repeatedly play back a specific section.

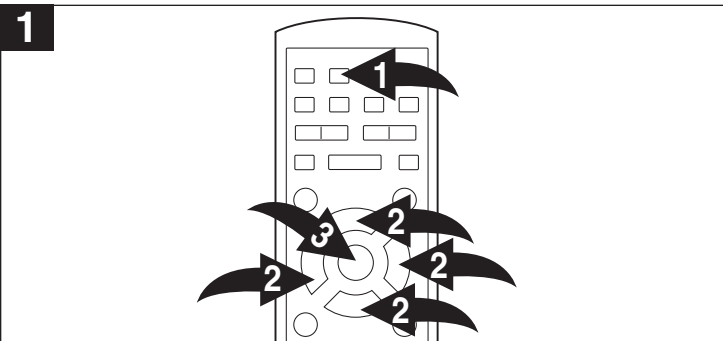

While in the Playback mode, press the DISPLAY button ❶ to bring up the control options. Select the Playback mode option using the Navigation (◀, ▶) buttons ❷, then press the ENTER button ❸.

Select A-B using the Navigation (▲, ▼) buttons ❹. Press the ENTER button ❺ when the desired starting segment is playing to set point A. Press the ENTER button ❻ again when the desired ending segment is playing to set point B; the unit will then automatically start playing this segment repeatedly. To cancel, press the ENTER button ❻ to highlight Playback mode, select NORMAL using the Navigation (▲, ▼) buttons ❷, then press the ENTER button ❸.

RANDOM PLAYBACK

While playing back a DVD, this unit can randomly playback the chapters inside the playback title.

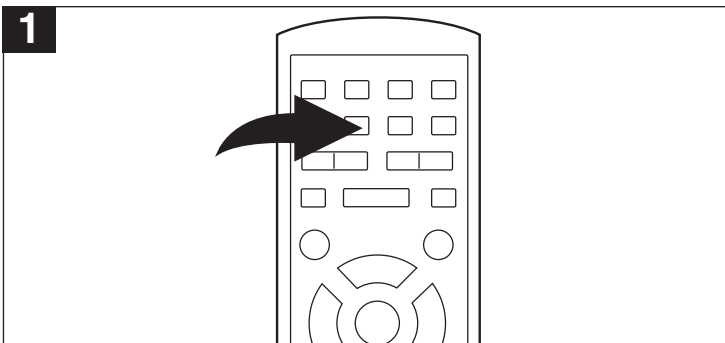

While in the Playback mode, press the RANDOM button; random playback will automatically begin. Press the RANDOM button again to resume normal playback.

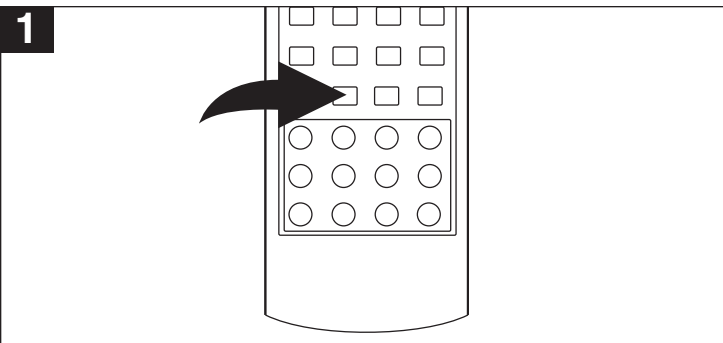

While in the Play mode, press the ANGLE button and the angle setting will appear at the top of the screen. The first number is the current angle and the second number is the total angles. Repeatedly press the ANGLE button to select the desired angle. This is not available on all discs.

DVD BASIC OPERATION (CONTINUED)

RETURN

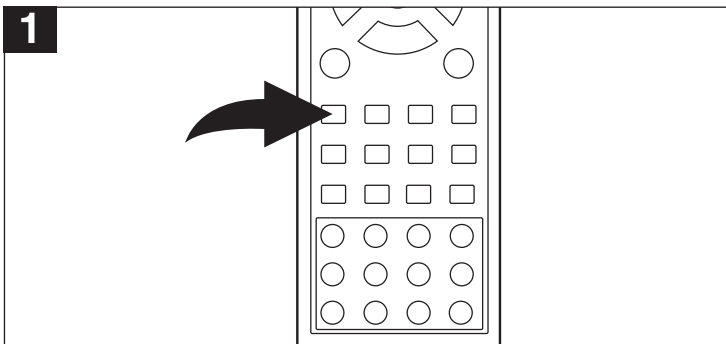

1 Press the RETURN button to return to the previous menu.

AUDIO

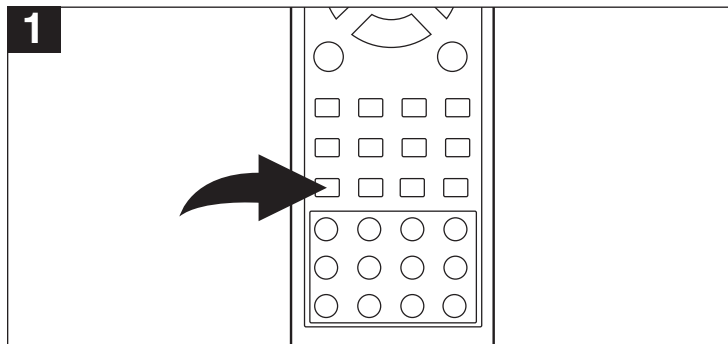

1 While in the Play mode, press the AUDIO button and the audio setting will appear at the top of the screen. The first number is the current audio setting and the second number is the total audio settings. Repeatedly press the AUDIO button to select the desired audio setting. This is not available on all discs.

DVD MENU

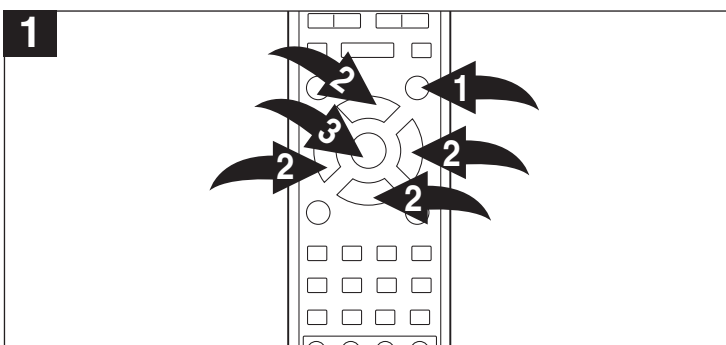

1 Press the MENU button ①, and the Main Menu of the disc will appear. Use the Navigation (◀, ▶, ▲, ▼) buttons ② to select the desired option, and then press the ENTER button ③.
This is not available on all discs.

TITLE MENU

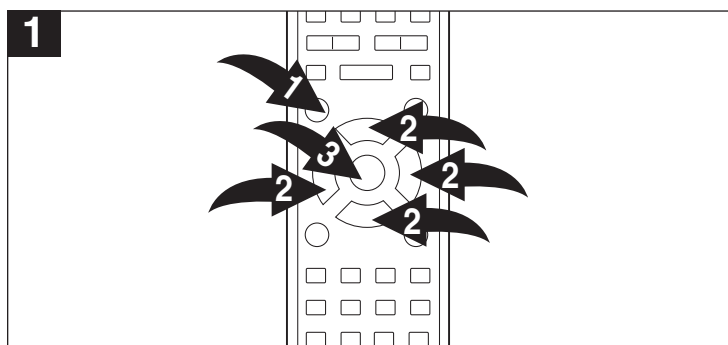

1 Press the TITLE button ①, and the Title Menu of the disc will appear. Use the Navigation (◀, ▶, ▲, ▼) buttons ② to select the desired option, and then press the ENTER button ③.
This is not available on all discs.

SUBTITLE MENU

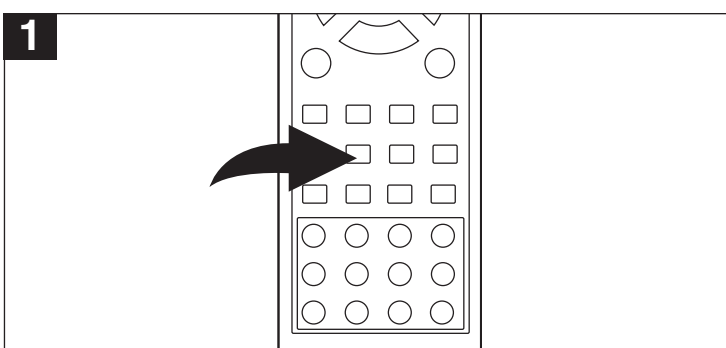

1 While in the Play mode, press the SUBTITLE button repeatedly to select a subtitle language or to turn the subtitle menu on/off. This feature is not available on all discs.

NOTES:

- Some DVDs have automatic subtitles by default, so you cannot turn subtitles on or off.
- After pressing the SUBTITLE button, subtitles may not appear immediately during some scenes.
- If subtitles are off and text still appears on the screen, make sure the Closed Captions option is off (see page 20).

DVD BASIC OPERATION (CONTINUED)

PROGRAMMED PLAYBACK

The DVD recorder in this unit has a 99 chapter programmable memory that allows you to program up to 99 chapters on any disc for playback in any desired order. You may program 99 different chapters or you may also program certain chapters to play more than once. To perform programmed playback, proceed as follows:

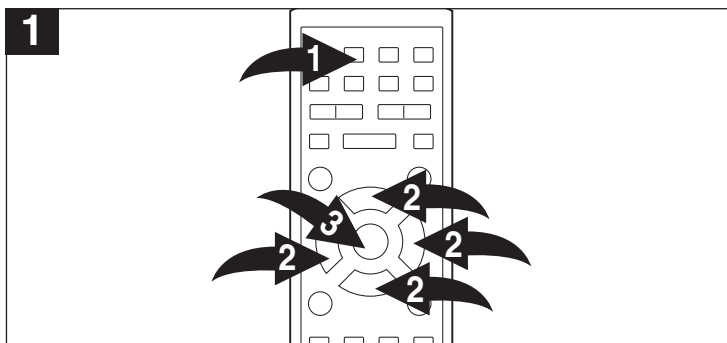

While in the Playback mode, press the DISPLAY button ❶ to bring up the control options. Select the Playback mode option using the Navigation (◀, ▶) buttons ❷, then press the ENTER button ❸. Select PROG using the Navigation (▲, ▼) buttons ❷, then press the ENTER button ❸.

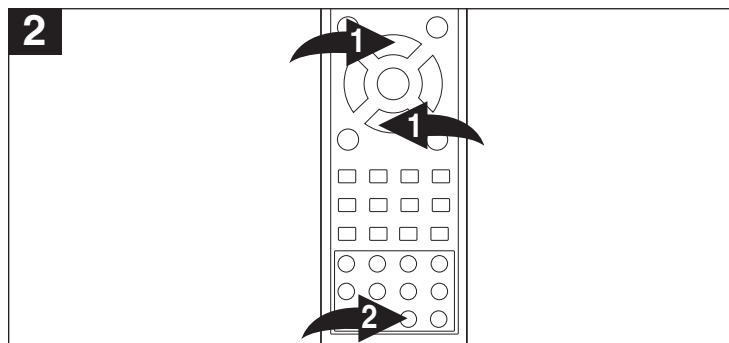

Two boxes will then appear on the screen; the left box will show all available titles on the DVD and the right box will show the program. To select a title to program, select a title using the Navigation (▲, ▼) buttons ❶, then press the ADD/CLEAR button ❷; it will then be added to the right program box.

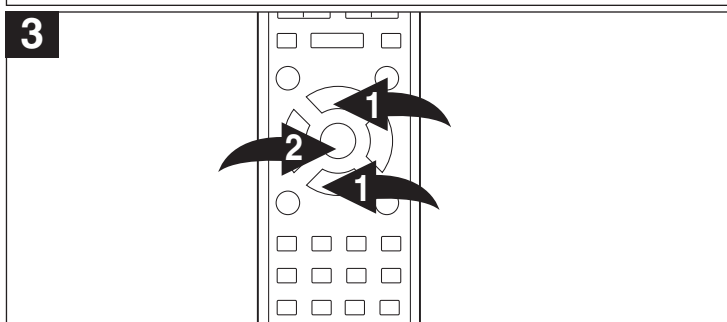

To select a chapter, select a title using the Navigation (▲, ▼) buttons ❶, then press the ENTER button ❷; the available chapters will then appear in the left box. Select the desired chapter to repeat using the Navigation (▲, ▼) buttons ❶, then press the ADD/CLEAR button ❸; it will then be added to the right program box. To go back to the Title menu, scroll to "--" and press the ENTER button ❷.

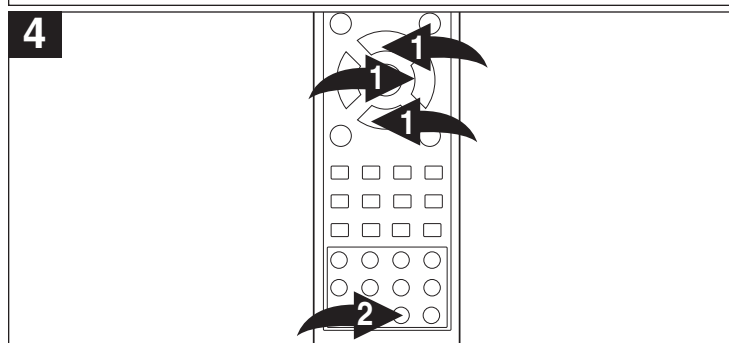

To delete a single chapter, select the right program box using the Navigation (▶) button ❶, then select the desired chapter to delete using the Navigation (▲, ▼) buttons ❶, followed by the ADD/CLEAR button ❷.

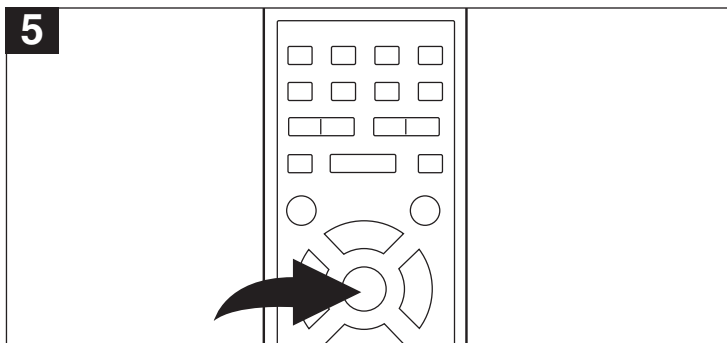

Select the top selection in the right program box, then click the ENTER button to start playback.

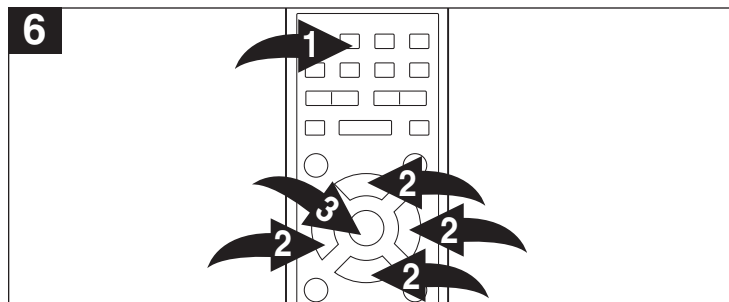

TO CANCEL THE PROGRAM PLAYBACK FUNCTION:

To cancel the Program Playback function, press the DISPLAY button ❶ to bring up the control options. Select the Playback mode option using the Navigation (◀, ▶) buttons ❷, then press the ENTER button ❸. Select NORMAL using the Navigation (▲, ▼) buttons ❷, then press the ENTER button ❸. The program will be kept until the disc is changed or the unit is turned off to the Standby mode.

MP3 BASIC OPERATION

PLAYBACK OF AN MP3 CD

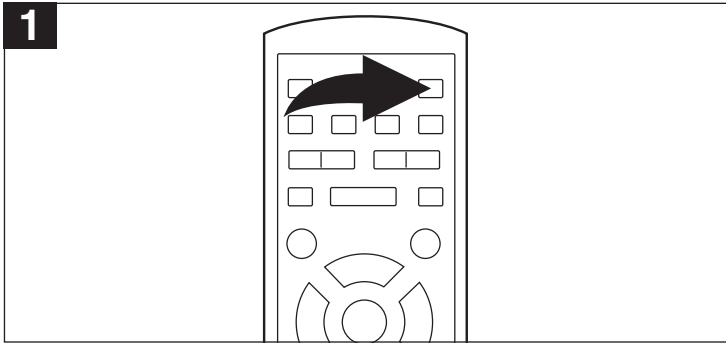

Press the ON/STANDBY button to turn on the unit; the STANDBY indicator will go out.

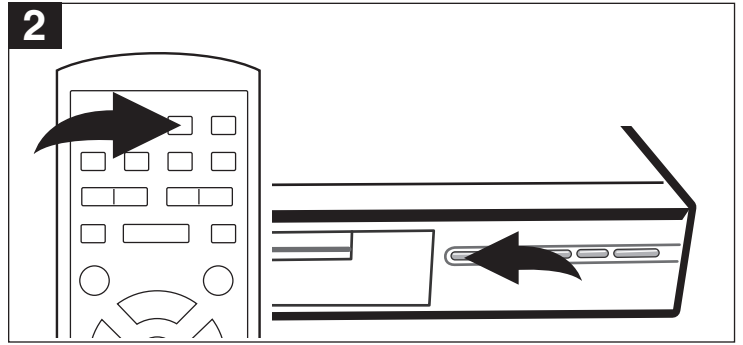

Press the OPEN/CLOSE button to open the disc tray, "OPEN" will appear on the screen and in the display. Insert an MP3 disc with the label side facing up on the disc tray.

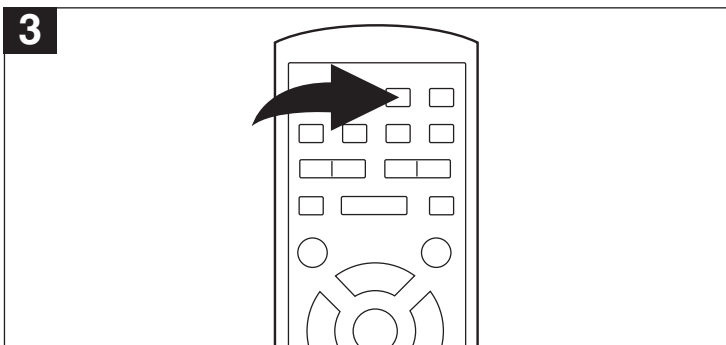

Press the OPEN/CLOSE button to close the disc tray. "LOAD" will appear on the screen and the display. After loading, two boxes will appear on the screen; the left box will show all available folders on the MP3 CD.

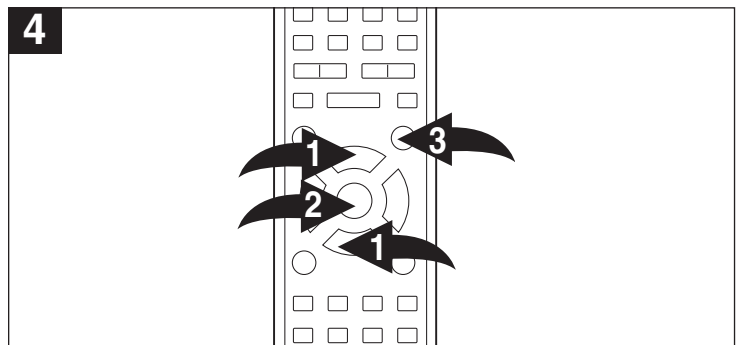

Select the desired folder using the Navigation (▲, ▼) buttons ❶, then press the ENTER button ❷; the files will then appear. To return to select other folders, press the MENU button ❸.

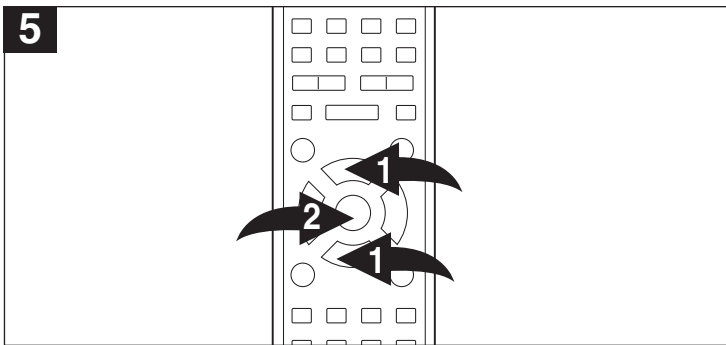

Select a file using the Navigation (▲, ▼) buttons ❶, then press the ENTER button ❷; the track will then play.

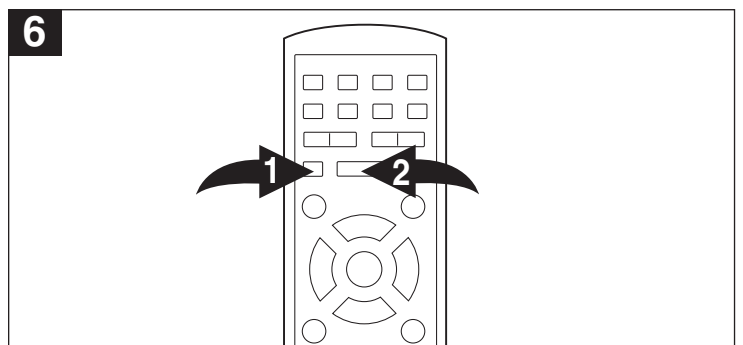

To pause playback, press the PAUSE button ❶; PAUSE will be highlighted on the screen. Press the PLAY (▶) button ❷ to resume playback.

MP3 BASIC OPERATION (CONTINUED)

RANDOM PLAY

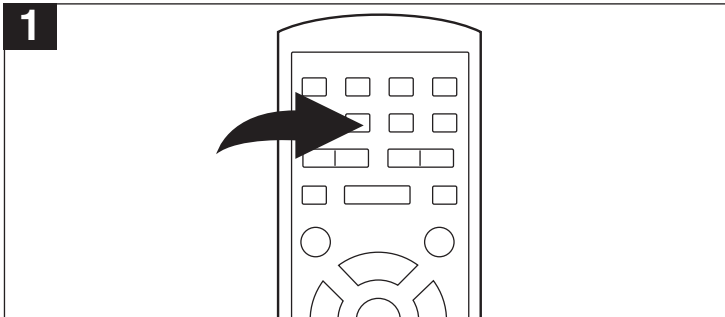

While in the Playback mode, press the RANDOM button; the unit will randomly playback the tracks inside the directory/folder then stop. Press the RANDOM button again to resume normal playback.

REPEAT PLAY

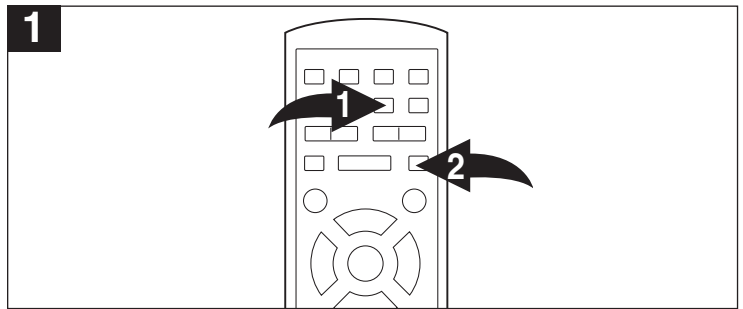

To Repeat play a track/file, simply select the track/file as described on the previous page, then press the REPEAT button ❶ once "S-RPT" will appear on the TV screen and the unit will repeat the selected track/file continuously until the STOP button ❷ is pressed.

To repeat the playing track's folder on an MP3 CD, simply select the track/file as described on the previous page. Then, press the REPEAT button ❶ a second time; "D-RPT" will appear on the TV screen and the unit will repeat the tracks/files inside the folder continuously until the STOP ❷ is pressed.

To cancel Repeat play, press the REPEAT button ❶ until "NORMAL" appears on the TV screen.

SELECTING FOLDERS/TRACKS

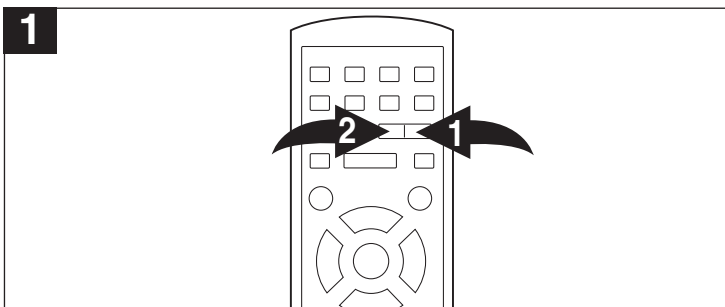

During playback, press the SKIP (▶▶) ❶ or (◀◀) ❷ button to skip to the next or previous track to be played.

AUDIO

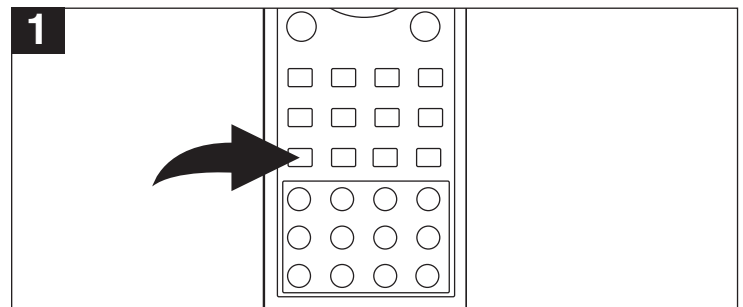

Press the AUDIO button repeatedly to select between LEFT, RIGHT or STEREO.

MP3 FAQs (Frequently Asked Questions)

Please read before playing an MP3 CD.

What is an MP3 file?

An MP3 file is a computer format that makes a large music file into a smaller one which is more convenient to download and share.

Can I record my own MP3 CDs?

Yes, but you need a CD recorder, which is available from your local computer store.

Where can I find MP3 files?

MP3 files are available on the internet.

Can this unit read regular music CDs?

Yes it can. However, you cannot mix MP3s and WAV files on the same CD. If you do this, the unit will play only the MP3 files.

Can I use the MP3 extension for non-audio data files?

No, this may result in a serious malfunction and harmful noise interference.

Can I mix MP3 files with other file types on the CDR?

Yes, but the unit will ignore those files and read only the MP3 files on the CDR.

Does this unit support subdirectories (subfolders)?

Yes, it can read MP3 files from subfolders.

MP3 BASIC OPERATION (CONTINUED)

PROGRAMMED PLAYBACK

This unit has a 99 track programmable memory that allows you to program up to 99 tracks on any disc for playback in any desired order. You may program 99 different tracks or you may also program certain tracks to play more than once. To perform programmed playback, proceed as follows:

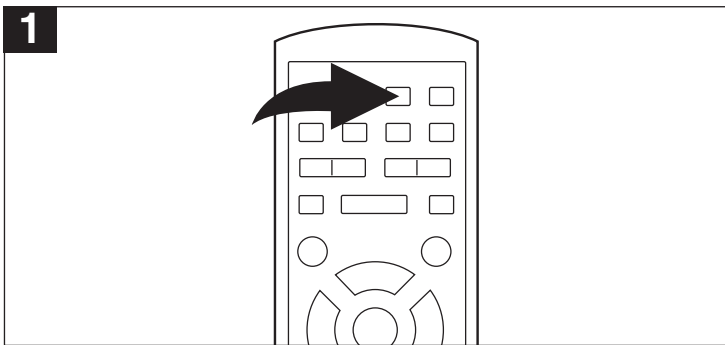

Press the OPEN/CLOSE button to open the disc tray, "OPEN" will appear in the display. Insert a disc with the label side facing up on the disc tray.

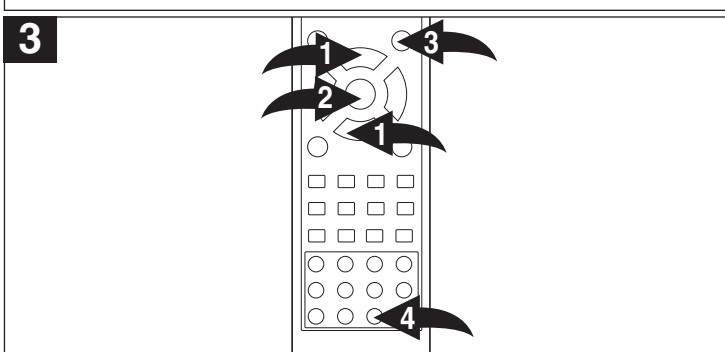

To select a track inside the folder, use Navigation (▲, ▼) buttons ❶ to select the desired folder, press the ENTER button ❷ then select the desired track by using Navigation (▲, ▼) buttons ❶. Press the ADD/CLEAR button ❸ to add the track to the right program box. To return to select other folder, Press the Menu button ❹

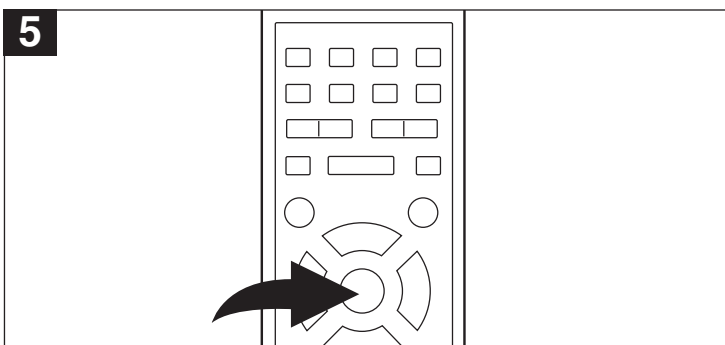

Select the top selection in the right program box, then click the ENTER button to start playback.

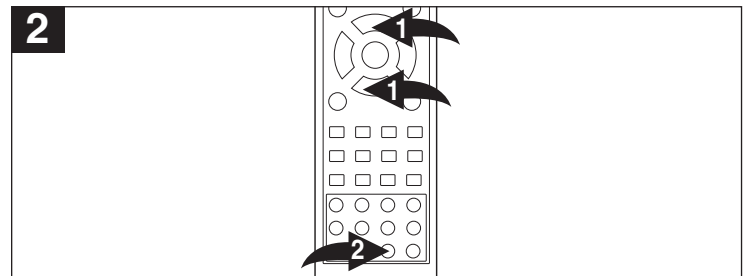

After loading, two boxes will appear on the screen; the left box will show all available folders/tracks on the disc and the right box will show the program. To select a track/folder to program, use Navigation (▲, ▼) buttons ❶ to select then press the ADD/Clear button ❷; the selected track will be added to the right program box. If you select a folder to add to the program box, all tracks in the folder will be added to the right program box.

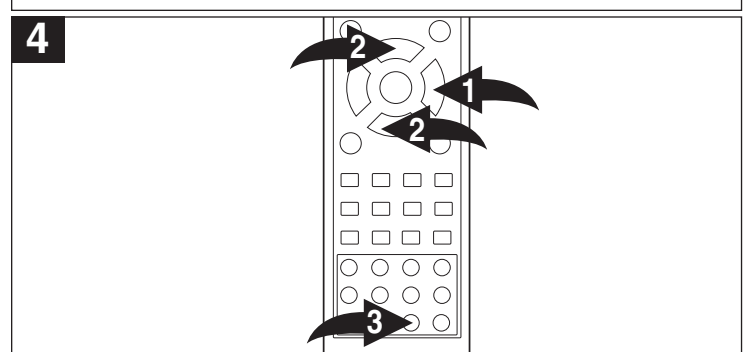

To delete a track, select the right program box using the Navigation (▶) button ❶, then select the desired chapter to delete using the Navigation (▲, ▼) buttons ❷, followed by the ADD/CLEAR button ❸.

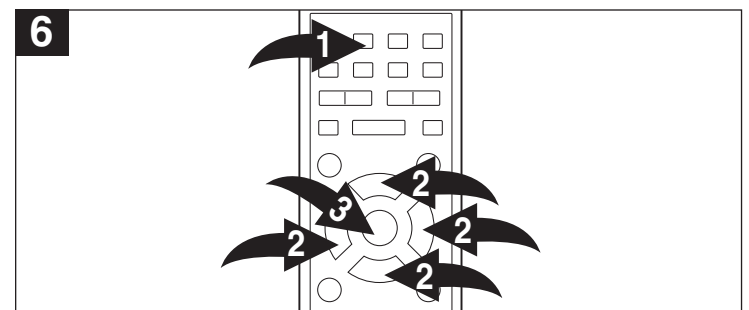

TO CANCEL THE PROGRAM FUNCTION:

To cancel the Program function, select the Playback mode option using the Navigation (◀, ▶) buttons ❷, then press the ENTER button ❸. Select NORMAL using the Navigation (▲, ▼) buttons ❷, then press the ENTER button ❸.

NOTE: Program will be kept until the unit is turned off (at Standby mode) or the disc is changed.

CD/VCD BASIC OPERATION

PLAYBACK OF A CD/VCD

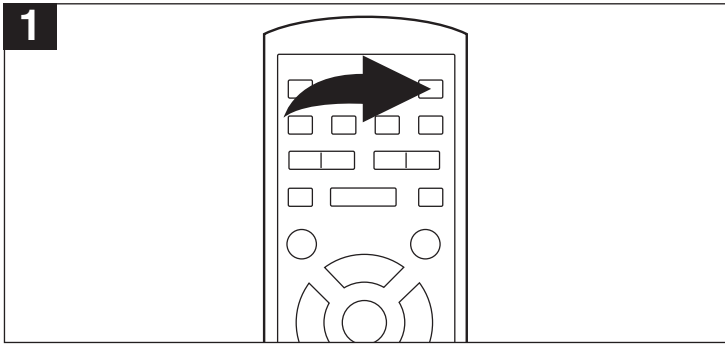

Press the ON/STANDBY button to turn on the unit; the STANDBY indicator will go out.

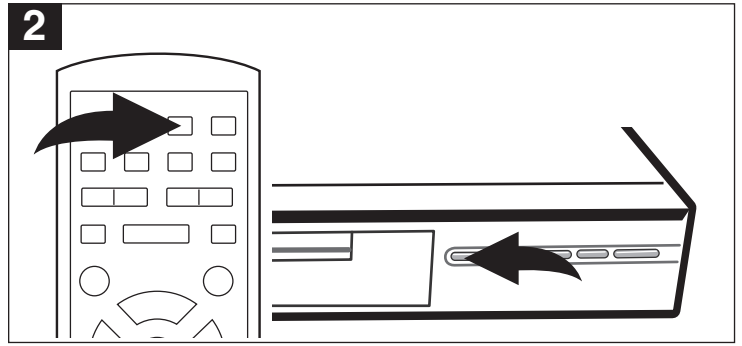

Press the OPEN/CLOSE button to open the disc tray, "OPEN" will appear on the screen and in the display. Insert a disc with the label side facing up on the disc tray.

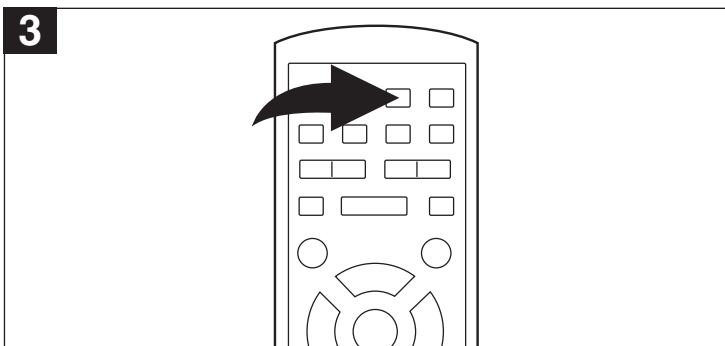

Press the OPEN/CLOSE button to close the disc tray. "LOAD" will appear on the screen and the display. After loading, playback will start immediately. For CD, two boxes will appear on the screen; the left box will show all available tracks on the CD.

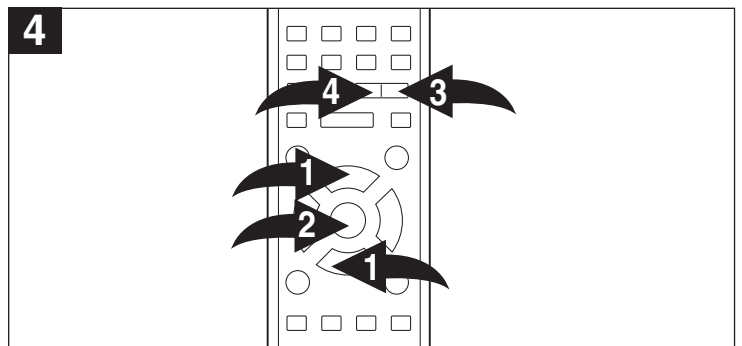

When playing back a CD, select the desired track using the Navigation (▲, ▼) buttons ①, then press the ENTER button ② to start playback of the selected track. When playing back a VCD, select the track using the SKIP (▶▶) ③ or (◀◀) ④ button.

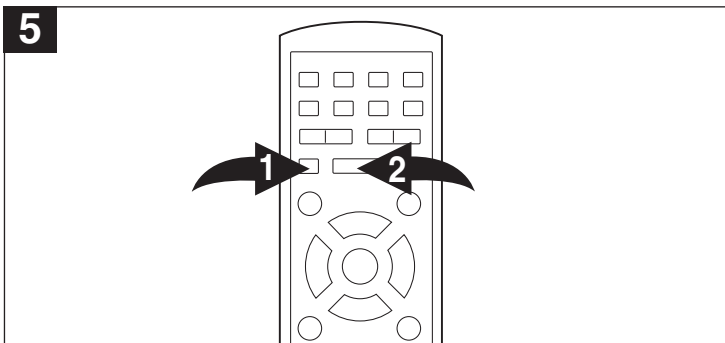

To pause playback, press the PAUSE button ①; PAUSE will appear on the screen. Press the PLAY (▶) button ② to continue playback.

For a VCD, press the PAUSE/STEP button ① to pause the picture. Repeatedly press the PAUSE/STEP button ① to play the VCD one frame at a time. Press the PLAY (▶) button ② to continue playing back the VCD.

TURNING PBC (PlayBack Control) ON OR OFF

When playing a VCD with PBC function, you can enjoy simple interactive software on your TV.

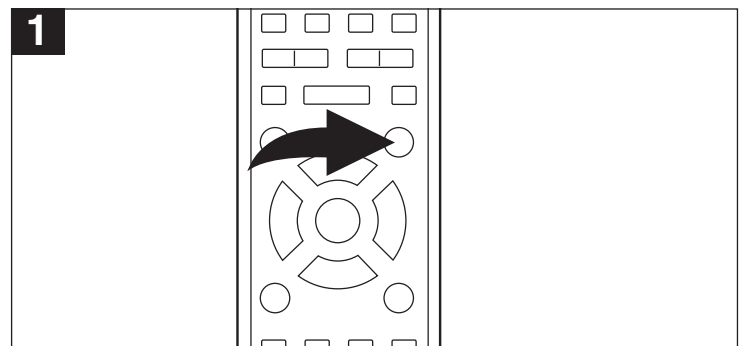

If the unit is in PBC On mode, press the MENU button to de-activate the PBC mode, Press the MENU button again to activate the PBC mode.

CD/VCD BASIC OPERATION (CONTINUED)

FORWARD ►►/REVERSE ◀◀

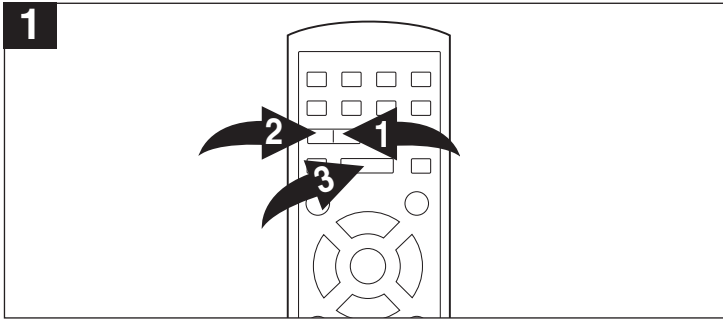

1 During playback, press either the Search ►► ❶ button or Search ◀◀ ❷ button to move the DVD forward or backward at double (x2) speed to locate a specific section. Repeatedly press these buttons and the speed will increase to x4 (x16, and x32 when playing a VCD). The disc will move forward or backward at high speed until the PLAY (►) button ❸ is pressed again; normal playback will resume at that point.

SELECTING TRACKS

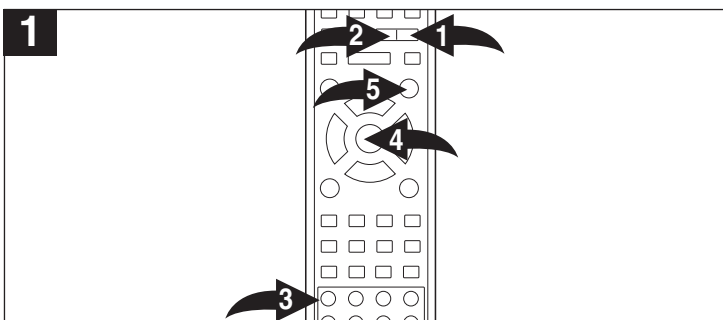

1 During playback, press the SKIP (►►) ❶ or (◀◀) ❷ button to skip to the next or previous track to be played. You can also use the Number buttons ❸ to enter the track number, then press the ENTER button ❹ to playback the selected track. If you cannot select the track of a VCD with the Number buttons ❸, press the MENU button ❺ to turn ON/OFF the PBC; then try again.

RANDOM PLAY

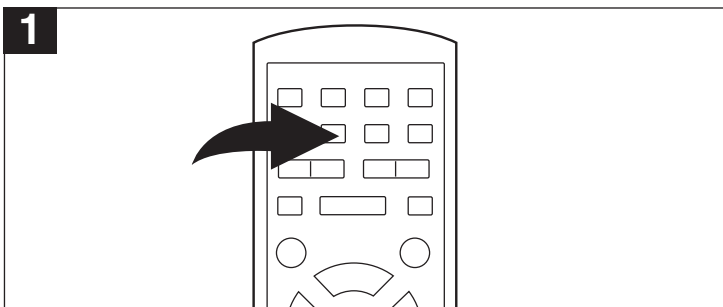

1 While in the Playback mode, press the RANDOM button; random playback will automatically begin. Press the RANDOM button again to resume normal playback.

REPEAT PLAY

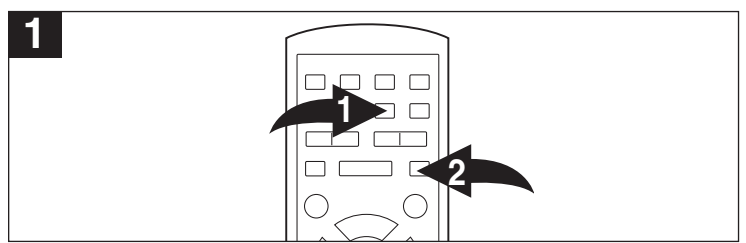

1 To Repeat a track, simply select the track as described on the previous page, then press the REPEAT button ❶ once "TR-RPT" will appear on the TV screen and the unit will repeat the selected track continuously until the STOP button ❷ is pressed.

To Repeat play all tracks on a CD, press the REPEAT button ❶ a second time; "D-RPT" will appear on the TV screen and the unit will repeat the CD continuously until the STOP button ❷ is pressed.

To cancel Repeat play, press the REPEAT button ❶ until "NORMAL" appears on the TV screen.

AUDIO

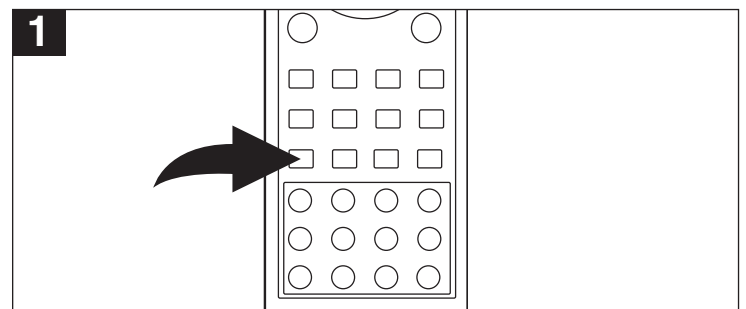

1 Press the AUDIO button repeatedly to select between LEFT, RIGHT or STEREO.

TIME SEARCH

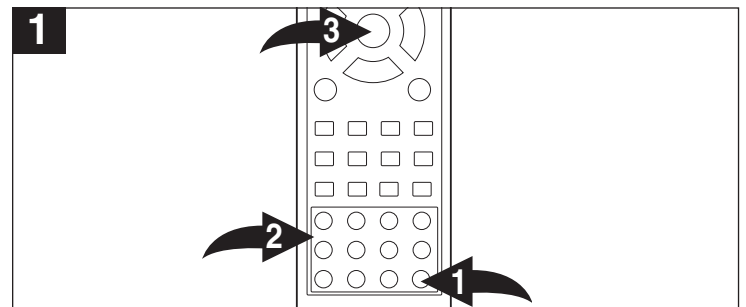

1 Press the GOTO button ❶ twice; the Elapsed Time option will be highlighted. Use the Number buttons ❷ to select the desired time you want to play, then press the ENTER button ❸; playback will start immediately.

CD/VCD BASIC OPERATION (CONTINUED)

PROGRAMMED PLAYBACK (CD)

This unit has a 99 track programmable memory that allows you to program up to 99 tracks on any disc for playback in any desired order. You may program 99 different tracks or you may also program certain tracks to play more than once. To perform programmed playback, proceed as follows:

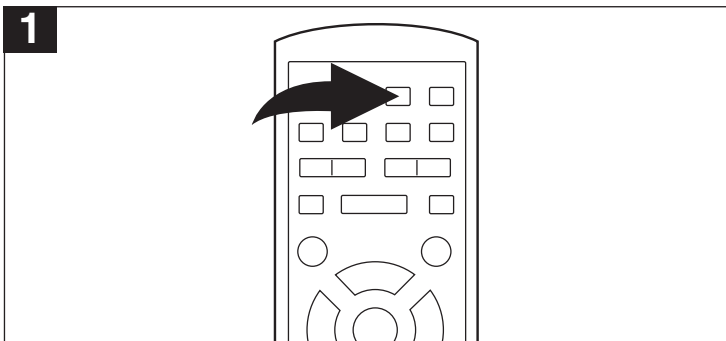

Press the OPEN/CLOSE button to open the disc tray, "OPEN" will appear in the display. Insert a disc with the label side facing up on the disc tray.

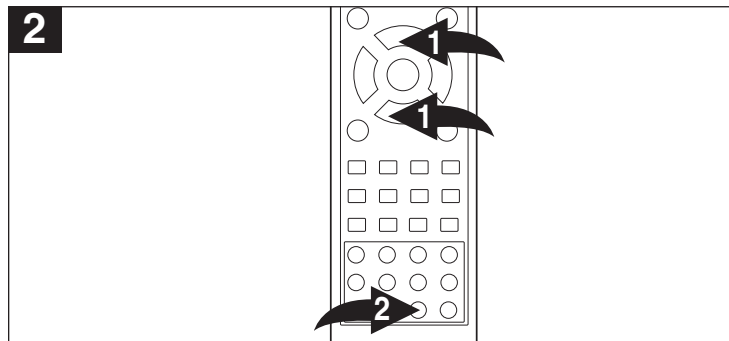

After loading, two boxes will appear on the screen; the left box will show all available tracks on the disc and the right box will show the program. To select a track to program, select a title using the Navigation (▲, ▼) buttons ❶, then press the ADD/CLEAR button ❷; it will then be added to the right program box.

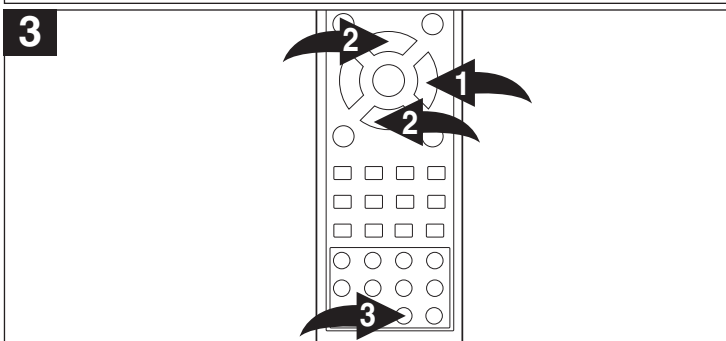

To delete a track, select the right program box using the Navigation (▶) button ❶, then select the desired chapter to delete using the Navigation (▲, ▼) buttons ❷, followed by the ADD/CLEAR button ❸.

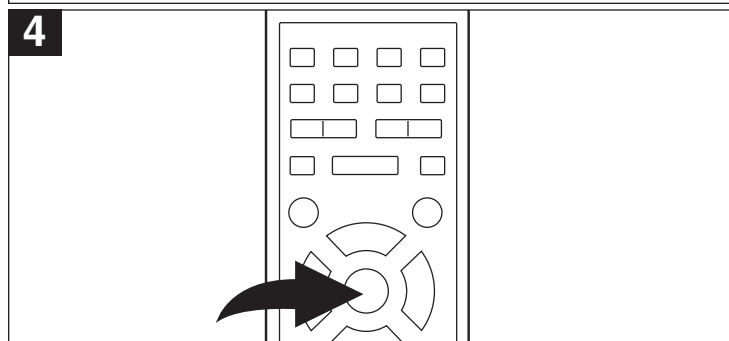

Select the top selection in the right program box, then click the ENTER button to start playback.

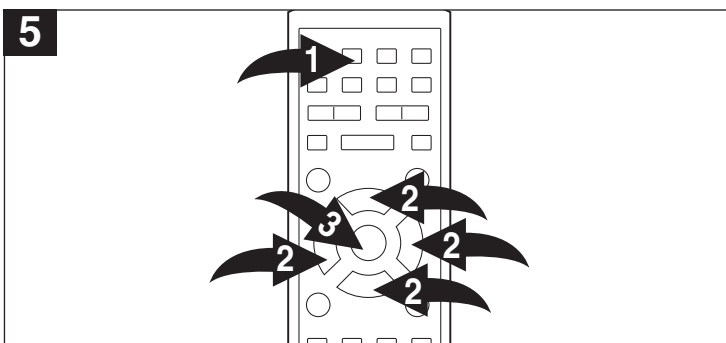

TO CANCEL THE PROGRAM FUNCTION:

To cancel the Program function, select the Playback mode option using the Navigation (◀, ▶) buttons ❶, then press the ENTER button ❷. Select NORMAL using the Navigation (▲, ▼) buttons ❸, then press the ENTER button ❹.

NOTE: The program memory will be kept until the disc is changed or the unit is turned off to the Standby mode.

CD/VCD BASIC OPERATION (CONTINUED)

PROGRAMMED PLAYBACK (VCD)

This unit has a 99 track programmable memory that allows you to program up to 99 tracks on any disc for playback in any desired order. You may program 99 different tracks or you may also program certain tracks to play more than once. To perform programmed playback, proceed as follows:

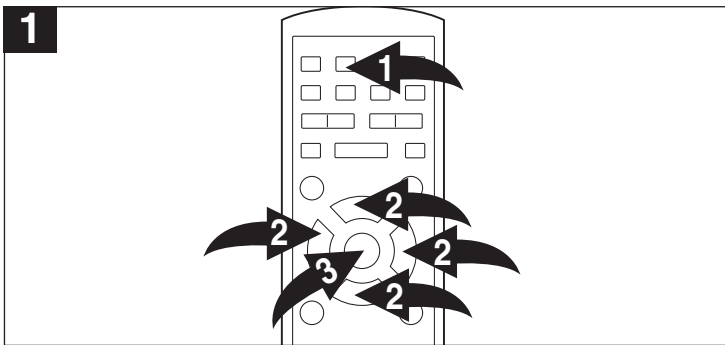

While in the Playback mode, press the DISPLAY button ❶ to bring up the control options. Select the Playback mode option using the Navigation (◀, ▶) buttons ❷, then press the ENTER button ❸. Select PROG using the Navigation (▲, ▼) buttons ❷, then press the ENTER button ❸.

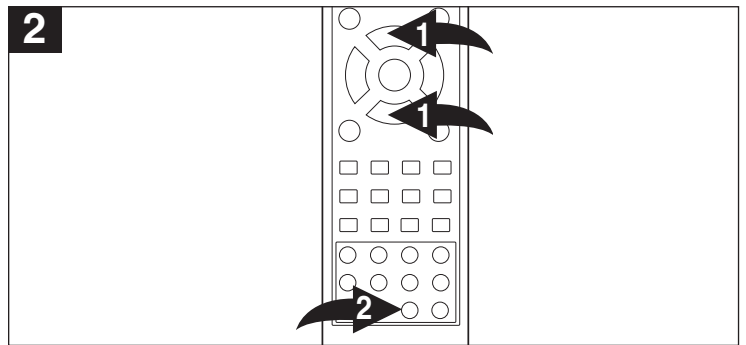

Two boxes will then appear on the screen; the left box will show all available tracks on the DVD and the right box will show the program. To select a track to program, select a track using the Navigation (▲, ▼) buttons ❶, then press the ADD/CLEAR button ❷; it will then be added to the right program box.

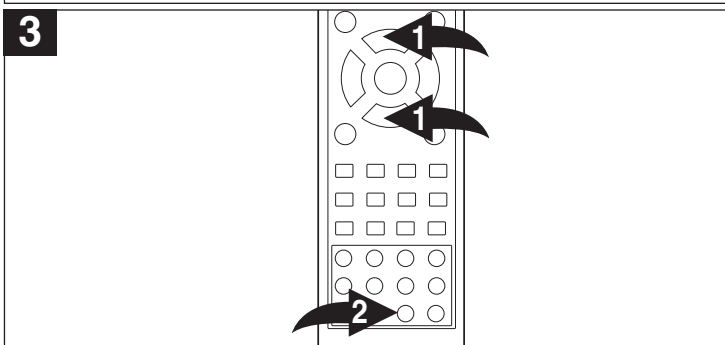

To delete a single track, select the right program box using the Navigation (▶) button ❶, then select the desired track to delete using the Navigation (▲, ▼) buttons ❶, followed by the ADD/CLEAR button ❷.

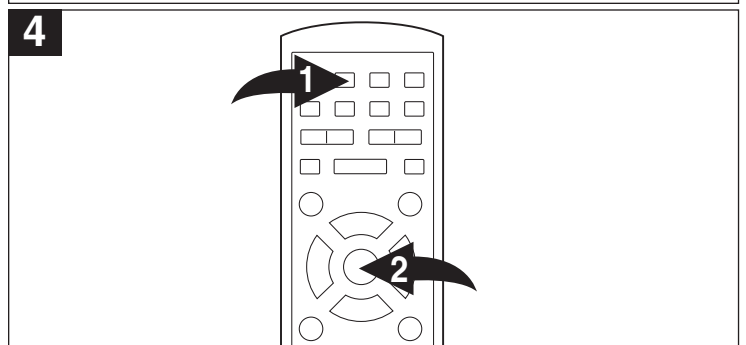

Select the top selection in the right program box, then click the ENTER button ❶ to start playback. Press the DISPLAY button ❷ to exit the DISPLAY MENU.

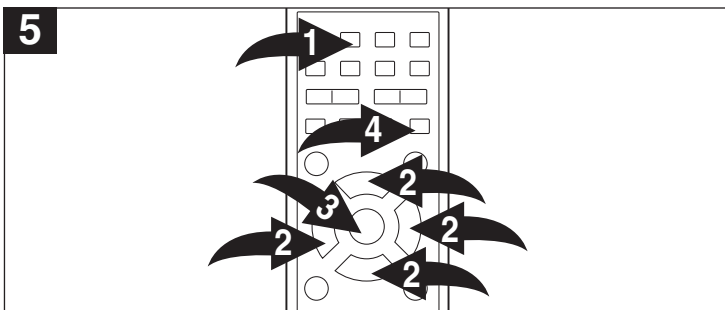

TO STOP/CANCEL THE PROGRAM FUNCTION:

To cancel the Program function, press the DISPLAY button ❶, select the Playback mode option using the Navigation (◀, ▶) buttons ❷, then press the ENTER button ❸. Select NORMAL using the Navigation (▲, ▼) buttons ❷, then press the ENTER button ❸ OR press the STOP button ❹ twice to stop the program playback.

NOTE: The program memory will be kept until the disc is changed or the unit is turned off to the Standby mode.

PICTURE CD BASIC OPERATION

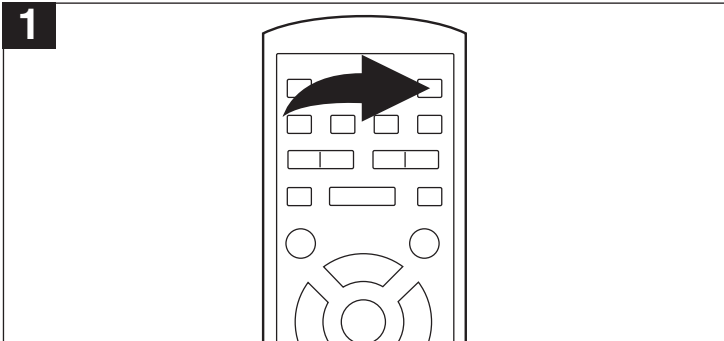

1 Press the ON/STANDBY button to turn on the unit; the STANDBY indicator will go out.

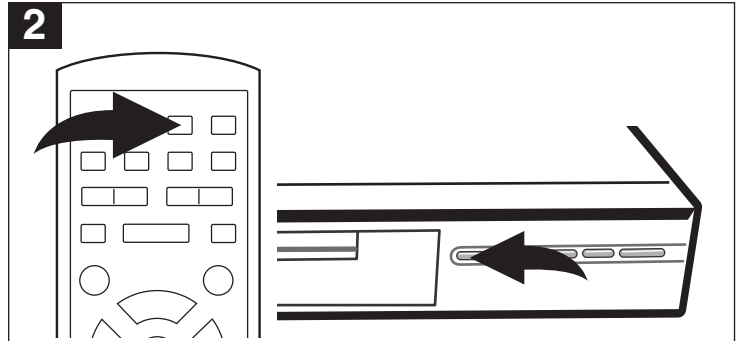

2 Press the OPEN/CLOSE button to open the disc tray, "OPEN" will appear in the display. Insert a picture CD with the label side facing up on the disc tray. Press the OPEN/CLOSE button again to close the disc tray. "LOAD" will appear on the TV screen. After loading, playback will start automatically.

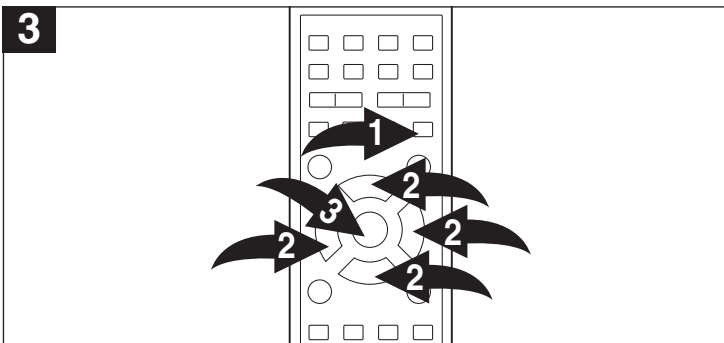

3 Press the STOP (■) button ① to show the picture show, select a picture using the Navigation (▲, ▼, ◀, ▶) buttons ②, then press the ENTER button ③; the picture will then appear on the screen, followed by the remaining pictures in the folder. Press the STOP (■) button ① to show the picture show.

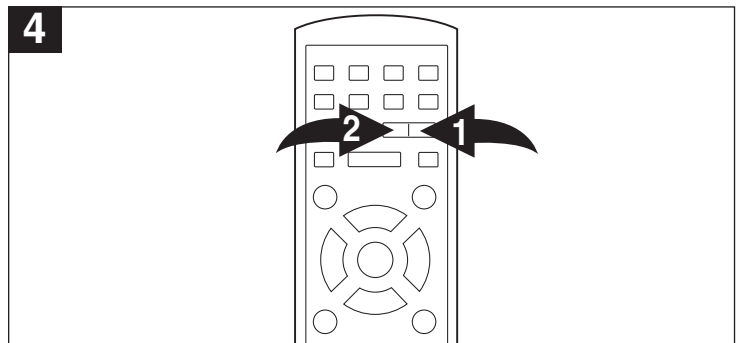

4 To skip to the next/previous page of the picture show, press the SKIP (▶▶) ① or (◀◀) ② button.

ZOOM

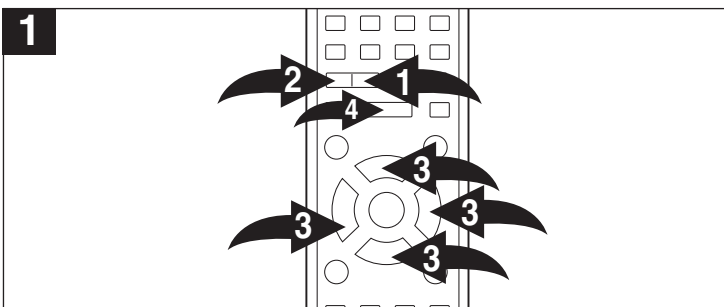

1 During playback, press the Search ▶▶ ① button or Search ◀◀ ② button repeatedly to zoom the picture in or out. Select (size of picture in TV screen) 1/8, 1/4, 1/2, x2, x4, x8 and Fit the screen. For the Zoom In function, use the Navigation (▲, ▼, ◀, ▶) buttons ③, to move the picture around the screen. When in the Zoom in/out mode, the playback will be paused. Press the Play (▶) button ④ to continue playing the pictures again.

ROTATE/FLIP

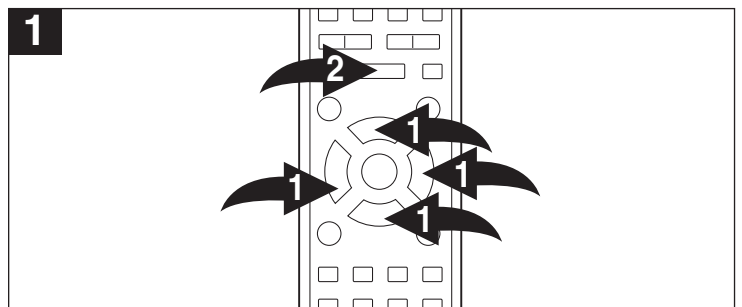

1 During playback, press Navigation (◀, ▶) buttons ① to rotate the picture. The picture will rotate 90 degrees with each press. To Flip the picture vertically or horizontally, press the Navigation Navigation (▲, ▼) buttons ①. When in the Rotate/Flip mode, the playback will be paused. Press the Play (▶) button ② to continue playing the pictures again.

RECORDING

IMPORTANT:

When “INVALID” appears while pressing a button, this means that the corresponding function cannot be performed either on the disc inserted, or in the selected mode.

DISPLAY BUTTON:

Insert a DVD+R or DVD+RW, during recording or if the source is set to Tuner, F-A/V, F-SV, R-A/V, R-SV or DV, press the DISPLAY button to view the control options. Press the Navigation (◀, ▶) buttons to select the desired icon, then press the ENTER button to select it. Once selected, press the Navigation (▲, ▼) buttons or the Number buttons to change the option, then the ENTER button to confirm the change.

When finished, press the DISPLAY button to remove the control options from the TV screen.

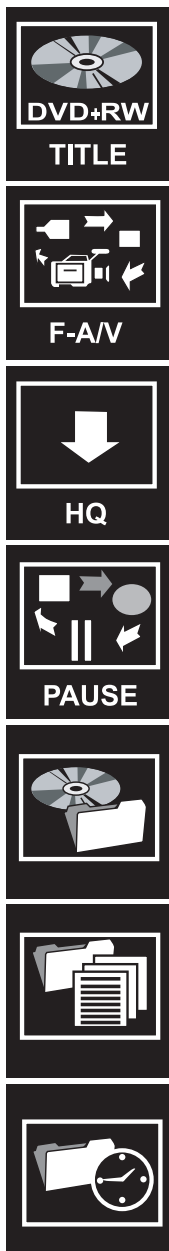
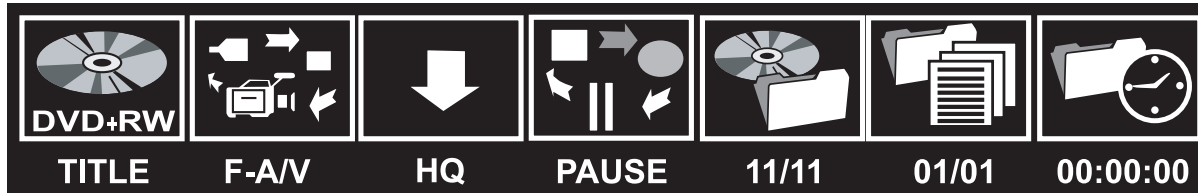

Append Mode: Record as a new title.

Source: Select the desired source (F-A/V jacks, R-A/V jacks, etc.)

Record Quality: Select one of the following: HQ (Highest Quality–60 minutes), SP (Standard Play–120 minutes), EP (Extended Play–240 minutes), SLP (Standard Long Play–360 minutes).

Mode Select the current mode, Stop or Record.

Titles: Shows the number of titles recorded on the inserted CD.

Chapter: When not recording, shows the number of chapters recorded on the last title of the DVD+R or DVD+RW disc. When recording, shows the current chapter number and the total number of the chapters on the current title.

Elapsed/Remaining Time: Cycles between the Remaining and the Elapsed times.

RECORDING (CONTINUED)

RECORDING

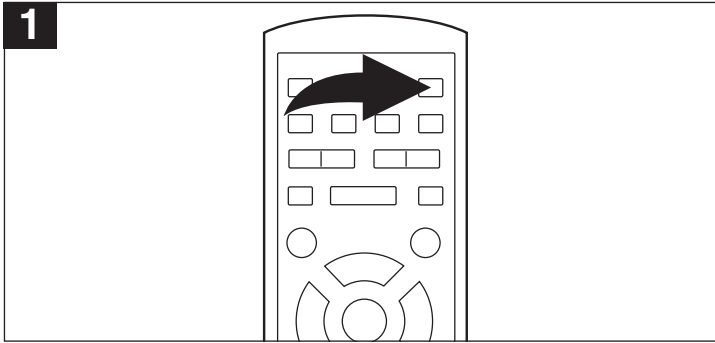

Press the ON/STANDBY button to turn on the unit; the STANDBY indicator will go out.

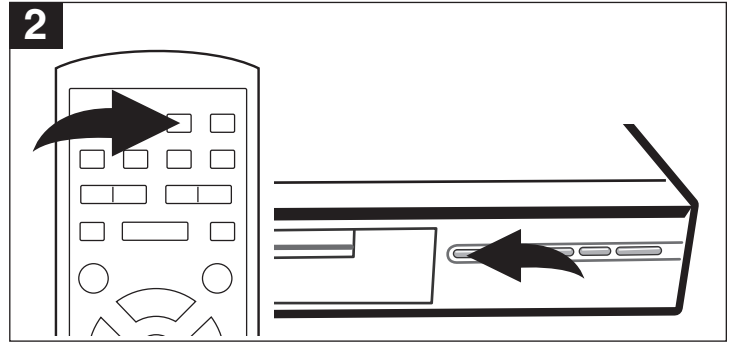

Press the OPEN/CLOSE button to open the disc tray, "OPEN" will appear in the display. Insert a DVD+R or DVD+RW with the label side facing up on the disc tray.

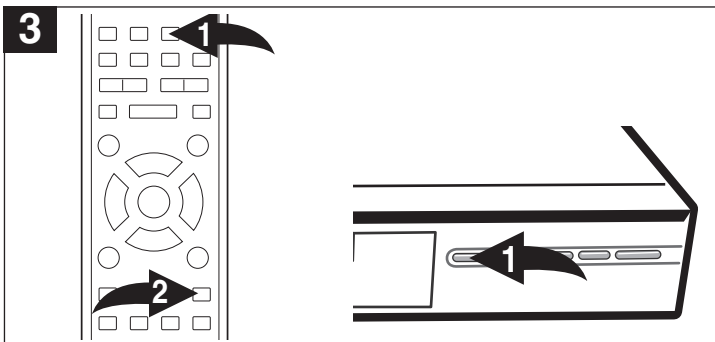

Set the options as desired (see the previous page). Press the OPEN/CLOSE button ❶ to close the disc tray. "LOAD" will appear on the screen and in the display. Press the SOURCE button ❷ repeatedly to select the desired recording source.

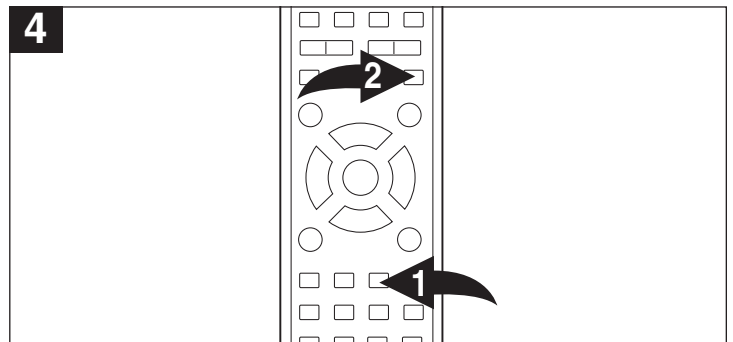

To start recording, press the RECORD button ❶; RECORD will appear on the TV screen and the unit will start recording after a few seconds ("STOP" will appear on the screen while the recorder is getting ready to record). When done recording, press the STOP button ❷; STOP will appear on the TV screen and the unit will stop recording after a few seconds.

NOTES:

- Up to 124 chapters can be recorded on a disc.
- The length of the recording is determined by the disc capacity and recording quality as set on page 43.
- Press the PAUSE/STEP button to pause recording. Press the RECORD button to resume recording.

TO SWITCH TO DVD PLAYBACK MODE

To switch to the DVD Playback mode from the Stop Recording mode, press the Play (▶) button; the index screen of the DVD+R or DVD+RW will appear on the screen. Refer to page 29 for playback of a Prerecorded DVD+R or DVD+RW.

RECORDING (CONTINUED)

ONE TOUCH RECORDING

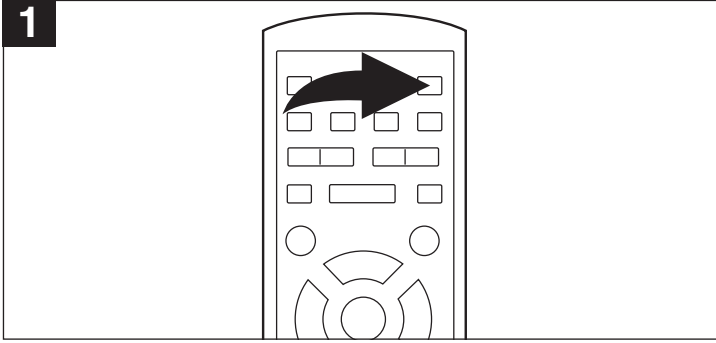

Press the ON/STANDBY button to turn on the unit; the STANDBY indicator will go out.

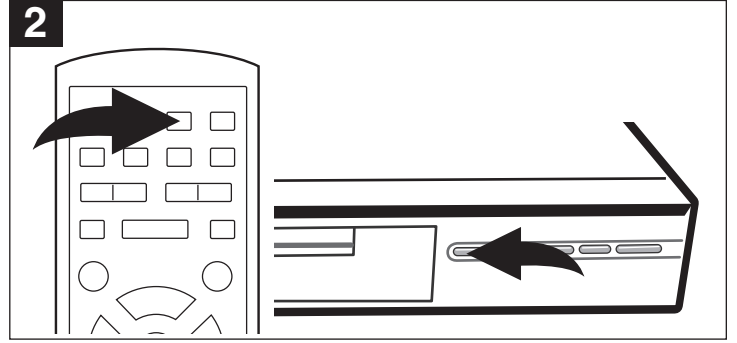

Press the OPEN/CLOSE button to open the disc tray, "OPEN" will appear on the screen and in the display. Insert a DVD+R or DVD+RW with the label side facing up on the disc tray.

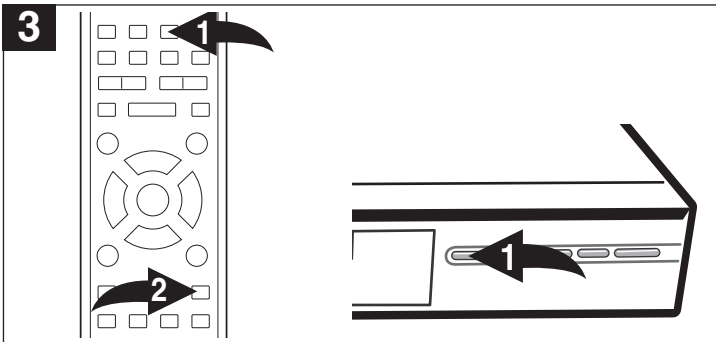

Set the options as desired (see the page 43). Press the OPEN/CLOSE button ❶ to close the disc tray. "LOAD" will appear on the screen and in the display. Press the SOURCE button ❷ to select the desired recording source.

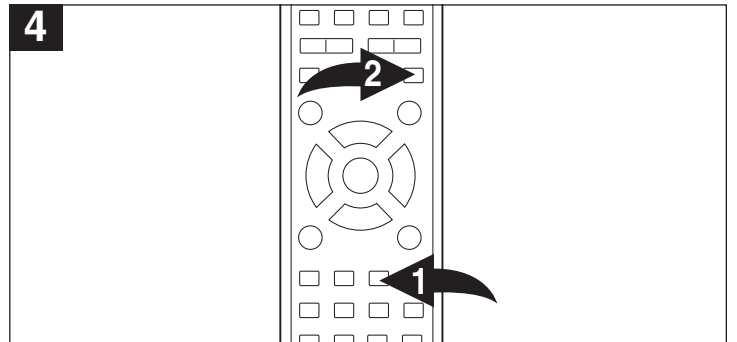

To start recording, press the RECORD button ❶; RECORD will appear on the TV screen and the unit will start recording after a few seconds. Press the RECORD button ❶ again and the unit will record for 30 minutes. Repeatedly press the RECORD button ❶ to increase the recording by 30 minutes each press. To stop recording before the preset stop time, press the STOP (■) button ❷; STOP will appear on the TV screen and the unit will stop recording after a few seconds.

NOTE:

- The length of one-touch recording is determined by the disc capacity and recording quality as set on page 42.

RECORDING (CONTINUED)

TIMER RECORD

Before setting the Timer Record, make sure the clock is set (see page 24).

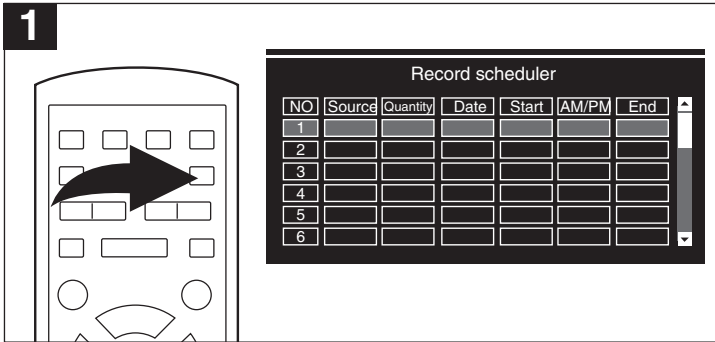

Press the **TIMER** button; the Record Scheduler box will appear.

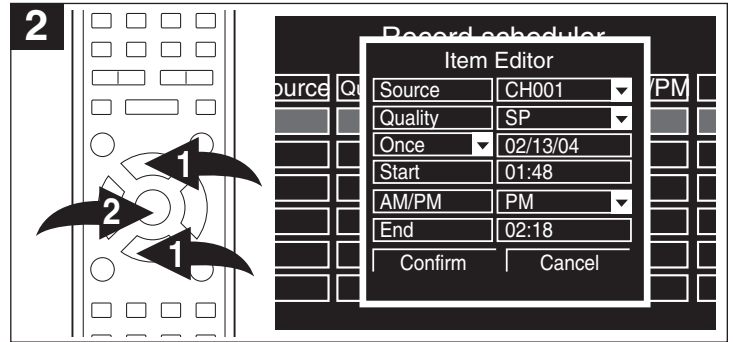

Press the Navigation (**▲**, **▼**) buttons ❶ followed by the **ENTER** button ❷ to select a schedule number.

NOTE: If no schedules have been set, then the first schedule number will be selected.

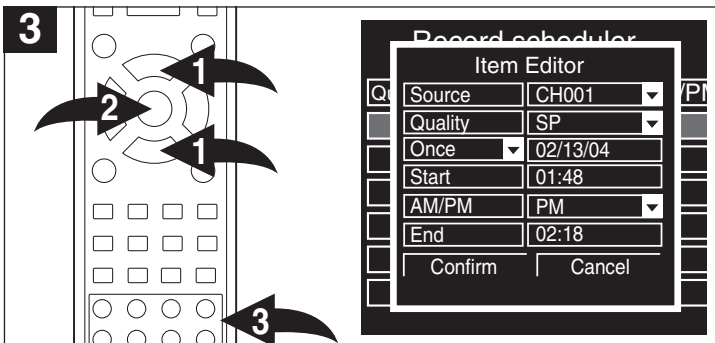

Use the Navigation (**▲**, **▼**) buttons ❶ to select **SOURCE** and press the **ENTER** button ❷ to confirm selection. Use the Navigation (**▲**, **▼**) buttons ❶ to select the options, then press the **ENTER** button ❷ to confirm. (For Entry Time or Date, using the Number button to input the time/date, then press the **ENTER** button ❷ to confirm. Repeat this procedure for the following:

QUALITY: Select the record quality (HQ, SP, EP or SLP).

FREQUENCY: Select how often you want the program recorded: Once, Daily or Weekly.

DATE: Set the desired date using the Number buttons ❸. Six digits must be pressed, two for the month, two for the date and two for the year.

START TIME: Set the desired start time using the Number buttons ❸.

AM/PM: Select AM or PM for the desired start time.

END TIME: Set the desired end time using the Number buttons ❸.

During input of the settings, if the entry is incorrect, the TV screen will show an "ERROR" message. When the error sentence occurs, you need to input the setting again.

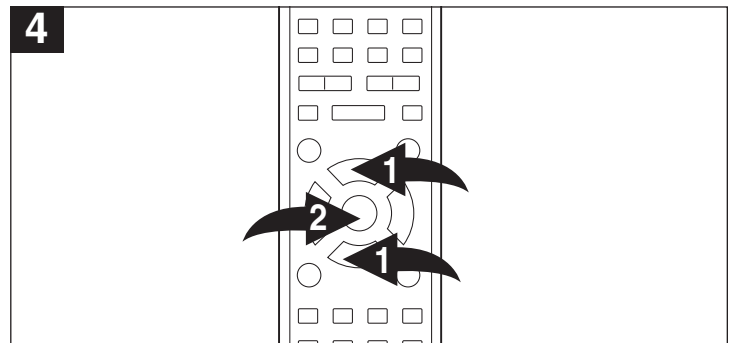

Select **CONFIRM** using the Navigation (**▲**, **▼**) buttons ❶ followed by the **ENTER** button ❷; the schedule will then be set.

Five minutes before the start time, a record dialog box will appear on the screen. To confirm recording, select **OK**, to cancel, select **CANCEL**.

Press the **TIMER** button to exit the Record Scheduler screen.

NOTE: If you do not select **OK** or **CANCEL**, after a few minutes, the Record dialog box will disappear and the recording will start when the Starting recording time is reached.

NOTES:

- Make sure a blank DVD+R or DVD+RW with enough space is inserted in the unit.
- If the unit is in the standby mode, it will wake up two minutes before recording.
- During recording, press the **STOP** (■) button to stop recording.
- The length of the recording is determined by the disc capacity and recording quality as set on page 42.
- To delete a schedule, highlight it using the Navigation (**▲**, **▼**) buttons, then press the **ADD/CLEAR** button.

RECORDING (CONTINUED)

Editing USING THE EDIT MENU

Insert a prerecorded DVD+RW into the unit; the index screen will appear. Use the Navigation (◀,▶,▲,▼) buttons to scroll to the desired title to play and the EDIT button to select it; the following screen will appear. Use Navigation (◀,▶) buttons to select the function icons in the TV screen.



Title: The first number is the current title and the second number is the total titles. Press the ENTER button to select this option and enter the desired title using the Number buttons, then press the ENTER button again. While in Edit mode, the selected title will be played back repeatedly.



Chapter: The first number is the current chapter and the second number is the total chapters in the Playback title. Press ENTER button to select this option and enter the desired chapter using the number buttons, then press the ENTER button again.

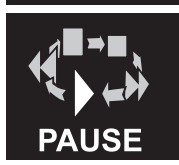

Playback Control: Press the ENTER button and select the desired playback control (fast forward, fast reverse, pause, etc.) by using the Navigation (▲,▼) buttons. Press the ENTER button again to confirm.



Chapter Editing: Select to add one chapter marker, delete the current chapter marker or delete all chapter markers. See the next page for details.

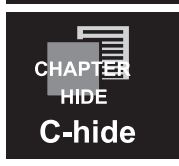

Chapter Hide/Unhide: Use the ENTER button to select between C-HIDE or C-UNHIDE.



Title Editing: Select to set the current image played back to the face of the title or to name the selected title. See the next page for details.



Elapsed/Remaining Time: Select to view the elapsed time or the remaining time using the Navigation (▲,▼) buttons

RECORDING (CONTINUED)

CHAPTER EDITING

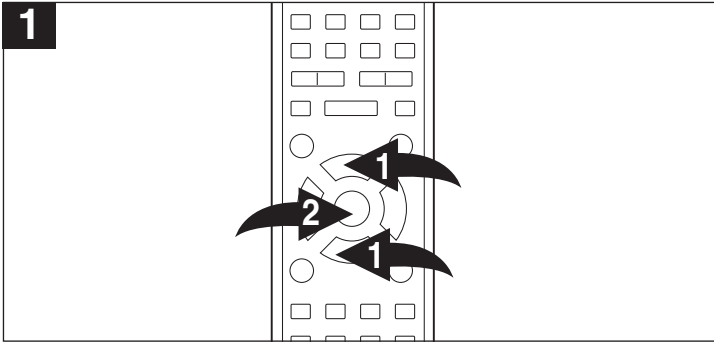

1 Select the Chapter Editing option as shown on the previous page. Select NEW using the Navigation (▲, ▼) buttons ❶, then press the ENTER button ❷; a new chapter marker will then be added at the current point.

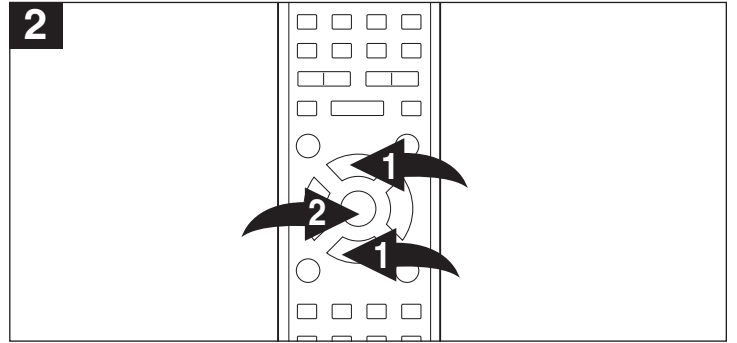

2 Select the Chapter Editing option as shown on the previous page. Select DELETE using the Navigation (▲, ▼) buttons ❶, then press the ENTER button ❷; the current chapter's marker will be deleted.

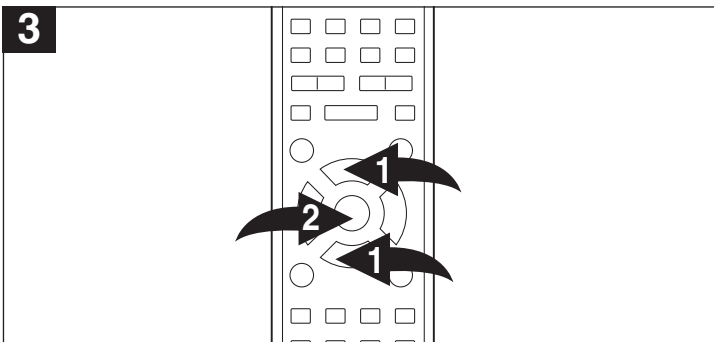

3 Select the Chapter Editing option as shown on the previous page. Select DEL ALL using the Navigation (▲, ▼) buttons ❶, then press the ENTER button ❷; all chapter markers in the current title will be deleted.

TITLE ICON AND TITLE NAME

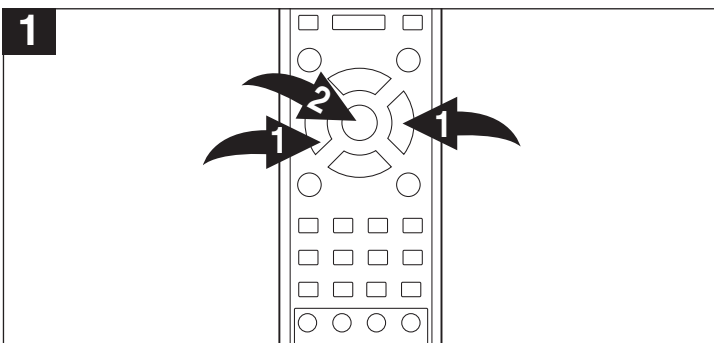

1 Select the Title option as shown on the previous page, then select the T-ICON using the Navigation (▲, ▼) buttons ❶. Press the ENTER button ❷ to select the current screen shot to be the index picture for using at the Index screen.

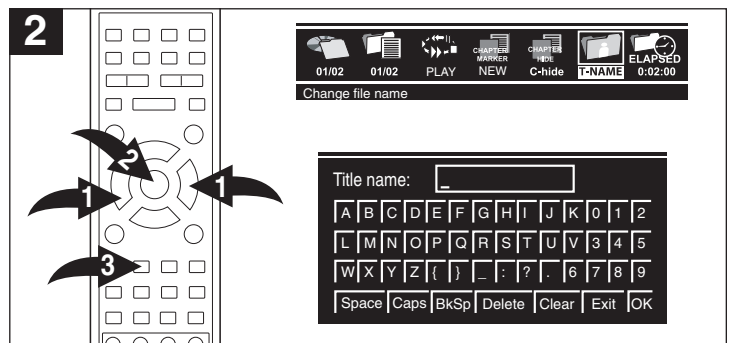

2 Select the Title Editing option as shown on the previous page. Select T-NAME using the Navigation (▲, ▼) buttons ❶, then press the ENTER button ❷; a keyboard will appear on the TV screen. Select the desired name of the title using (maximum nine characters) the Navigation (◀, ▶, ▲, ▼) buttons ❸ to select the desired letter, then press the ENTER button ❷ to select it. When the complete title has been entered, select OK, then press the ENTER button ❷. Press the EDIT button ❸ to exit the EDIT MENU and return to the index screen.

RECORDING (CONTINUED)

DISC OPERATION (DISC OP) BUTTON

With a Prerecorded DVD+R (Non-Finalize) or a DVD+RW in the disc compartment, press the DISC OP button on the remote control to view the Disc Operation options. Press the Navigation (◀, ▶) buttons to select the desired icon, then press the ENTER button to select it. Once selected, press the Navigation (▲, ▼) buttons or the Number buttons to change the option, then the ENTER button to confirm the change.

When finished, press the DISC OP button to remove the control options from the TV screen.

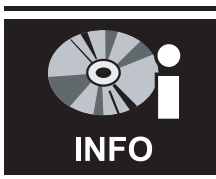
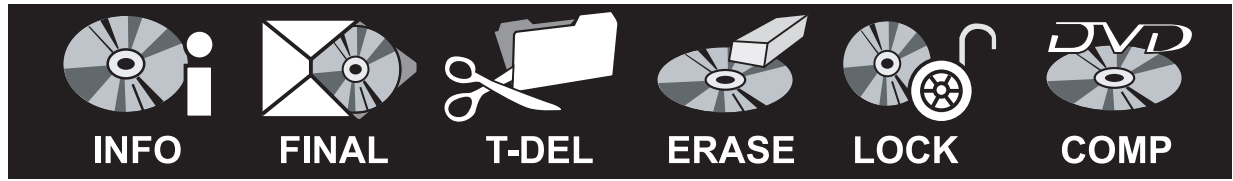

Info: Select this option to see the disc information (Disc Type, Title Numbers, Recorded Time, Remaining Time and Disc Status).



Finalize (DVD+R ONLY): Select this option, then press the ENTER button to finalize a DVD. Once finalized, you cannot record or edit anymore, but the DVD will be able to play on other DVD recorders.



Title Delete (DVD+RW ONLY): Select this option, then press the ENTER button to delete the last title.



Erase (DVD+RW ONLY): Select this option, then press the ENTER button to delete the whole DVD.

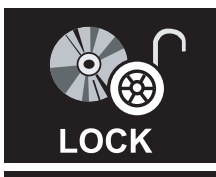

Lock (DVD+RW ONLY): Press the ENTER button to select LOCK and the current disc will be locked and cannot be changed. Press the ENTER button again to select UNLOCK and the current disc will be unlocked and changes can be made.



Compatible: Select this option, then press the ENTER button to make the inserted DVD compatible with other DVD recorders.

IMPORTANT: if the DVD+R or DVD+RW is blank, you can only choose between INFO or ERASE option. Other options will not be available for a blank disc.

NOTE: The Recorder may need several seconds or minutes to make the above changes.

TROUBLESHOOTING GUIDE

Check the following before requesting service:

SYMPTOM	POSSIBLE CAUSE	POSSIBLE SOLUTION
GENERAL		
No power.	AC cord unplugged.	Plug in the AC cord to an AC outlet.
Power on, but unit not functioning properly.	Condensation has formed.	Unplug the unit and wait about one to two hours to allow the player to dry.
	Wrong type of CD inserted.	This unit cannot play discs, other than DVD, VCD, MP3 or standard CDs.
	Unit needs to be reset.	Press the ON/STANDBY button, then unplug the power cord. Wait one minute and then plug the unit back in.
	The disc is dirty or inserted incorrectly.	Clean disc and insert label side-up.
	Some features and functions are not available on all discs.	This is normal, try another function.
No picture.	The equipment is not connected properly.	Connect the equipment according to the instructions in this manual.
	The INPUT of the TV is not set to receive the DVD signal output.	Select the appropriate video input mode, usually VIDEO or A/V.
	The video cables are not securely connected.	Connect the video cables securely.
	The connected TV's power is off.	Turn the TV on.
No sound.	The equipment is not connected properly.	Connect the equipment according to the instructions in this manual.
	The equipment connected with the audio cable is not set to receive the DVD signal input.	Select the appropriate audio input mode.
	The audio cables are not securely connected.	Connect the audio cables securely.
	The connected receiver's power is off.	Turn the audio receiver on.
The playback picture is poor.	The disc is dirty.	Clean the disc.
The Search feature is not working.	Some discs have sections that do not allow searching.	This is normal on some discs.
The picture is not fitting properly.	Wrong menu option is selected in the SETUP MENU.	Select the correct TV type (16:9, Panscan or Letterbox) which matches the TV.
The remote control is not working.	The batteries are weak or dead.	Install fresh batteries.
	The batteries are not installed properly.	Install batteries according to the diagram.
	The remote is not aimed at the sensor.	Aim the remote at the sensor.
	Distance is too far or there is too much light in the room.	Operate within 20ft, or reduce the light in the room.
	There is an obstacle in the path of the beam.	Move obstacle.

TROUBLESHOOTING GUIDE (CONTINUED)

SYMPTOM	POSSIBLE CAUSE	POSSIBLE SOLUTION
DVD		
The unit does not start playback.	Rating level set to block the DVD.	Enter your password, and/or change the rating level.
	DVD not inserted, or inserted upside-down.	Insert DVD correctly.
	A non-playback disc is inserted.	Make sure to insert a DVD
	The disc is not placed in the guide.	Place the disc on the disc tray correctly inside the guide.
	The disc is dirty.	Clean the disc.
Some functions do not operate as stated.	Some features and functions are not available on all discs.	This is normal, try another function.
Selected language is not being shown in the subtitles, or spoken.	If the audio or subtitle language does not appear on the disc, then the initial setting will not be seen/heard.	This is normal, try another disc.
Subtitles are not working properly.	Subtitles appear only when the discs contain them.	This is normal, try another disc.
	Subtitles not turned on.	Turn the subtitles on.
Angle cannot be changed.	Angles may not be recorded on the disc (see disc jacket/case), or they may only be recorded on certain scenes.	Try another disc, or wait for a scene which allows a different camera angle.
The Rating Level password has been forgotten.	Call the number listed on the warranty to get the information to reset the password.	After receiving the information, reset the password and write it down.
VCD (VIDEO CD)		
No menu playback.	The VCD inserted does not have the playback control.	Try another VCD.
DVD RECORDER		
Will not record.	The wrong disc type is inserted.	Use a DVD+RW or DVD+R only.
	The DVD is full.	Insert a blank DVD+R or DVD+RW.
	The DVD is locked.	Unlock the DVD (see page 49).
	No signal from the selected source.	Check the input signal connection or make sure the correct source has been selected.
A recorded DVD will not play in another player.	The DVD+R has not been finalized.	Finalize the CD—see page 49.
	The DVD has not been made compatible.	Make compatible—see page 49.

**FOR ADDITIONAL SET-UP OR OPERATING ASSISTANCE, PLEASE VISIT OUR WEBSITE AT
WWW.MEMOREXELECTRONICS.COM OR CONTACT CUSTOMER SERVICE AT
1-800-4MEMCRP (1-800-469-6877)**

**PLEASE KEEP ALL PACKAGING MATERIAL FOR AT LEAST 90 DAYS IN CASE YOU NEED TO RETURN
THIS PRODUCT TO YOUR PLACE OF PURCHASE OR MEMOREX.**

FOR PARTS AND ACCESSORIES, CONTACT FOX INTERNATIONAL AT 1-800-321-6993.

CARE AND MAINTENANCE

Caring for Discs

- Treat the disc carefully. Handle the disc only by its edges. Never allow your fingers to come in contact with the shiny, unprinted side of the disc.

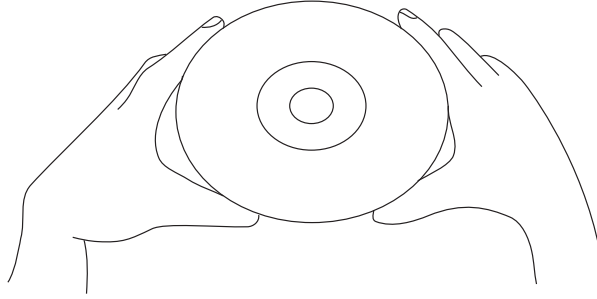

- Do not attach adhesive tape, stickers, etc. to the disc label.
- Clean the disc periodically with a soft, lint-free, dry cloth. Never use detergents or abrasive cleaners to clean the disc. If necessary, use a CD cleaning kit.
- If a disc skips or gets stuck on a section of the disc, it is probably dirty or damaged (scratched).
- When cleaning the disc, wipe in straight lines from the center of the disc to the outer edge of the disc. Never wipe in circular motions.

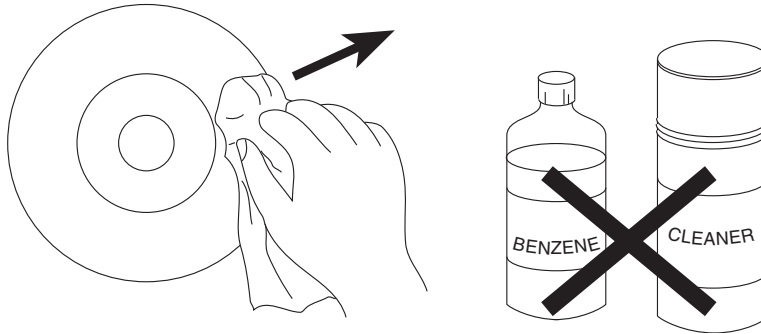

- Discs should be stored in their cases after each use to avoid damage.
- Do not expose discs to direct sunlight, high humidity, high temperatures or dust, etc. Prolonged exposure or extreme temperatures can warp the disc.
- Do not stick or write anything on either side of the disc. Sharp writing instruments, or the ink, may damage the surface.

Cleaning the Unit

- To prevent fire or shock hazard, disconnect your unit from the AC power source when cleaning.
- The finish on your unit may be cleaned with a dust cloth and cared for as other furniture. Use caution when cleaning and wiping the plastic parts.
- Mild soap and a damp cloth may be used on the front panel.

SPECIFICATIONS

Power Requirements.....	AC120V, 60Hz
Power Consumption.....	35W (approx. 5 W when set to Standby mode)
Weight	11.3 Lbs
Dimensions	16.875 (L) x 12.375 (W) x 2.5 (H) inches
Weight and dimensions are approximate.	
Signal System	NTSC/PAL
Operating Temperature	+5° to +35°C
Operating Humidity Range.....	5% to 90% (no condensation)

Discs Played:

DVD-VIDEO Disc

- 12cm single-sided, single layer
- 12cm single-sided, dual layer
- 12cm double-sided, single layer
- 8cm single-sided, single layer
- 8cm single-sided, dual layer
- 8cm double-sided, single layer

COMPACT DISC (VIDEO CD)

- 12cm disc
- 8cm disc

Video Output Level	1Vp-p
Audio Output Level.....	1Vrms (1 KHz, 0dB)

Audio Signal Output Characteristics:

Frequency Responses:

DVD (Linear Audio).....	20Hz-20KHz (48KHz/96KHz sampling)
CD Audio	20Hz-20KHz
S/N Ratio.....	70dB
Wow and Flutter.....	Below Measurable Level

Pickup:

Wavelength.....	655nm
Laser Power	Class 1

Recording:

Recording Format	DVD Video Recording Format
Recording Disc	4.7GB DVD+R/DVD+RW

Specifications are subject to change without notice.

Memcorp, Inc.
Weston, FL
Printed in Hong Kong

Visit our website at www.memorexelectronics.com